



OPERATING INSTRUCTIONS

RD-8504
Audio/Video Receiver



Introduction

READ THIS BEFORE OPERATING YOUR UNIT



CAUTION
RISK OF ELECTRIC SHOCK
DO NOT OPEN



CAUTION : TO REDUCE THE RISK OF ELECTRIC SHOCK, DO NOT REMOVE COVER (OR BACK). NO USER-SERVICEABLE PARTS INSIDE. REFER SERVICING TO QUALIFIED SERVICE PERSONNEL.



This symbol is intended to alert the user to the presence of uninsulated "dangerous voltage" within the product's enclosure that may be of sufficient magnitude to constitute a risk of electric shock to persons.



This symbol is intended to alert the user to the presence of important operating and maintenance (servicing) instructions in the literature accompanying the appliance.

WARNING : TO REDUCE THE RISK OF FIRE OR ELECTRIC SHOCK, DO NOT EXPOSE THIS APPLIANCE TO RAIN OR MOISTURE.

Caution regarding installation

Note : For heat dispersal, do not install this unit in a confined space such as a bookcase or similar enclosure.

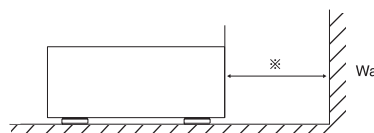
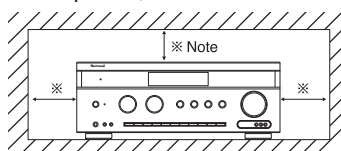

Do not block ventilation openings or stack other equipment on the top.

FOR YOUR SAFETY

EUROPE
AUSTRALIA

220 V
-
240 V

Units shipped to Australia are designed for operation on 240 V AC only. To ensure safe operation, the three-pin plug supplied must be inserted only into a standard three-pin power point which is effectively earthed through the normal household wiring. Extension cords used with the equipment must be three-core and be correctly wired to provide connection to earth. Improper extension cords are a major cause of fatalities. The fact that the equipment operates satisfactorily does not imply that the power point is earthed and that the installation is completely safe. For your safety, if in any doubt about the effective earthing of the power point, consult a qualified electrician.
PAN-EUROPEAN UNIFIED VOLTAGE
All units are suitable for use on supplies 220-240 V AC.

CAUTION

- Leave a space around the unit for sufficient ventilation.
- Avoid installation in extremely hot or cold locations, or in an area that is exposed to direct sunlight or heating equipment.
- Keep the unit free from moisture, water, and dust.
- Do not let foreign objects in the unit.
- The ventilation should not be impeded by covering the ventilation openings with items, such as newspapers, table-cloths, curtains, etc.
- No naked flame sources, such as lighted candles, should be placed on the unit.
- Please be care the environmental aspects of battery disposal.
- The unit shall not be exposed to dripping or splashing for use.
- No objects filled with liquids, such as vases, shall be placed on the unit.
- Do not let insecticides, benzene, and thinner come in contact with the set.
- Never disassemble or modify the unit in any way.
- Notes on the AC power cord and the wall outlet.
- The unit is not disconnected from the AC power source(mains) as long as it is connected to the wall outlet, even if the unit has been turned off.
- To completely disconnect this product from the mains, disconnect the plug from the wall socket outlet.
- When setting up this product, make sure that the AC outlet you are using is easily accessible.
- Disconnect the plug from the wall outlet when not using the unit for long periods of time.

Information for Users on Collection and Disposal of Old Equipment and used Batteries



These symbols on the products, packaging, and/or accompanying documents mean that used electrical and electronic products and batteries should not be mixed with general household waste. For proper treatment, recovery and recycling of old products and used batteries, please take them to applicable collection points, in accordance with your national legislation.



By disposing of these products and batteries correctly, you will help to save valuable resources and prevent any potential negative effects on human health and the environment which could otherwise arise from inappropriate waste handling.



For more information about collection and recycling of old products and batteries, please contact your local municipality, your waste disposal service or the point of sale where you purchased the items.

Pb

[Information on Disposal in other Countries outside the European Union]

These symbols are only valid in the European Union. If you wish to discard these items, please contact your local authorities or dealer and ask for the correct method of disposal.

Note for the battery symbol (bottom two symbol examples):

The sign Pb below the symbol for batteries indicates that this batteries contains lead.

CONTENTS

• Introduction	
READ THIS BEFORE OPERATING YOUR UNIT	2
• System Connections	4
• Front Panel Controls	11
• Universal Remote Controls	13
OPERATING COMPONENTS WITH REMOTE CONTROL	15
REMOTE CONTROL OPERATION RANGE	15
LOADING BATTERIES	15
USING FUNCTIONS OF REMOTE CONTROL	16
• Operations	
LISTENING TO A PROGRAM SOURCE	19
SURROUND SOUND	21
ENJOYING SURROUND SOUND	23
LISTENING TO RADIO BROADCASTS	27
LISTENING TO RDS BROADCASTS (FM ONLY)	29
(RDS Tuner (Regional Option for some countries in Europe, etc))	
RECORDING	31
DIGITAL AUDIO RECORDING WITH MD RECORDER	32
OTHER FUNCTIONS	33
ROOM 2 SOURCE PLAYBACK	34
• OSD Menu Settings	36
SETTING THE SYSTEM SETUP	40
SETTING THE SPEAKER / ROOM EQ SETUP	43
SETTING THE INPUT SETUP	51
SETTING THE MULTI ROOM SETUP	56
SETTING THE SOUND PARAMETER	57
SETTING THE ADVANCED VIDEO	58
• Troubleshooting Guide	59
• Specifications	60
• Setup Code Table	61

System Connections

- Please be certain that this unit is unplugged from the AC outlet before making any connections.
- Since different components often have different terminal names, carefully read the operating instructions of the component connected.
- Be sure to observe the color coding when connecting audio, video and speaker cords.
- Make connections firmly and correctly. If not, it can cause loss of sound, noise or damage to the receiver.

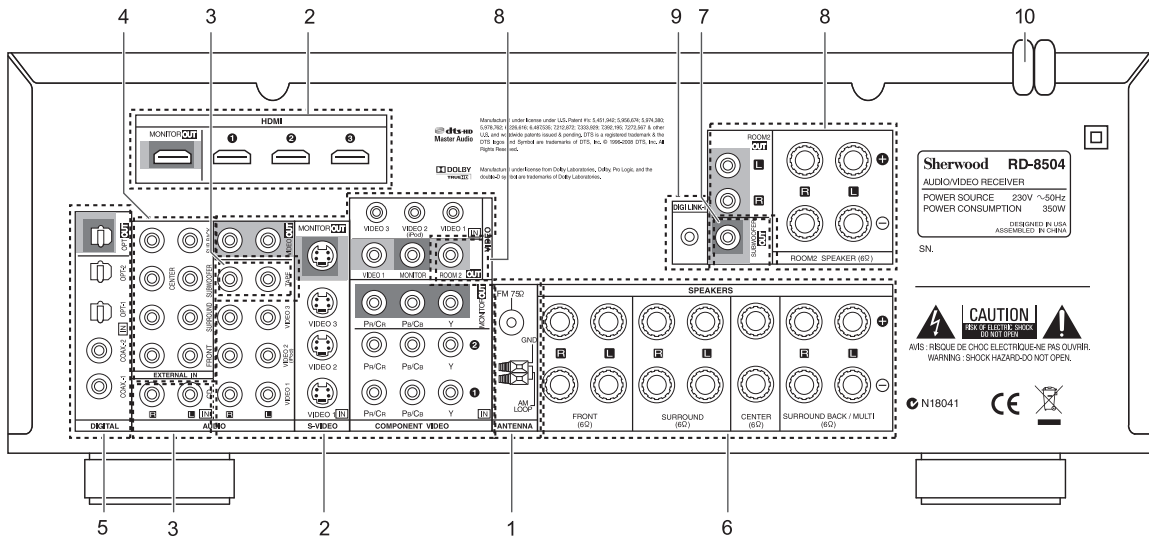

1. CONNECTING ANTENNAS

FM Indoor Antenna

FM Outdoor Antenna

- Change the position of the FM indoor antenna until you get the best reception of your favorite FM stations.
- A 75Ω outdoor FM antenna may be used to further improve the reception. Disconnect the indoor antenna before replacing it with the outdoor one.

AM Loop Antenna

AM Outdoor Antenna

- Place the AM loop antenna as far as possible from the receiver, TV set, speaker cords and the AC input cord and set it to a direction for the best reception.
- If the reception is poor with the AM loop antenna, an AM outdoor antenna can be used in place of the AM loop antenna.

2. CONNECTING VIDEO COMPONENTS

- The jacks of VIDEO 1 may also be connected to a DVD recorder or other digital video recording component. For details, refer to the operating instructions of the component to be connected.
- The jacks of VIDEO 2/VIDEO 3 can also be connected to an additional video component such as a cable TV tuner or satellite system.
- Connect the jacks of VIDEO 3 to the video component in the same way.
- There are three types of video jacks (COMPONENT, S-VIDEO, (composite) VIDEO) for analog video connections and the HDMI connectors for digital video and audio connections. Connect them to the corresponding video jacks according to their capability.
- For your reference, the excellence in picture quality is as follows : "HDMI" > "COMPONENT" > "S-VIDEO" > "(composite) VIDEO" .
- When making COMPONENT VIDEO connections, connect "Y" to "Y", "Pb/Cb" to "Cb"(or "B-Y", "Pb") and "Pr/Cr" to "Cr"(or "R-Y", "Pr").
- When recording video program sources through VIDEO 1 OUT jack or viewing video program sources through MONITOR OUT or ROOM 2 OUT jack, you must use the same type of video jacks that you did connect to video playback components such as DVD player, cable TV tuner, etc.

Video conversion

- Depending on the Video Mode settings, this unit converts the video input signal (such as component video signal, S-Video signal and composite video signal) and outputs from the HDMI MONITOR OUT. (For details, refer to "When selecting the Video Mode" on page 52.)

Notes :

- You can connect Apple iPod to this receiver via Sherwood iPod dock. If Sherwood iPod dock is connected to DIGI LINK-i jack for system control, you should connect its video and audio jacks to the "VIDEO 2" jacks of this receiver. Because, when you control your iPod with the unit's remote control, the VIDEO 2/iPod is automatically selected as an input source and the corresponding operation is performed.
- The OSD menu and the momentary OSD can be displayed via the HDMI MONITOR OUT only. However, when the Video Scaling is set to HDMI Bypass and the video signals are input into the HDMI IN, the momentary OSD cannot be displayed via the HDMI MONITOR OUT. (For details, refer to "When selecting the Video Scaling" on page 53.)

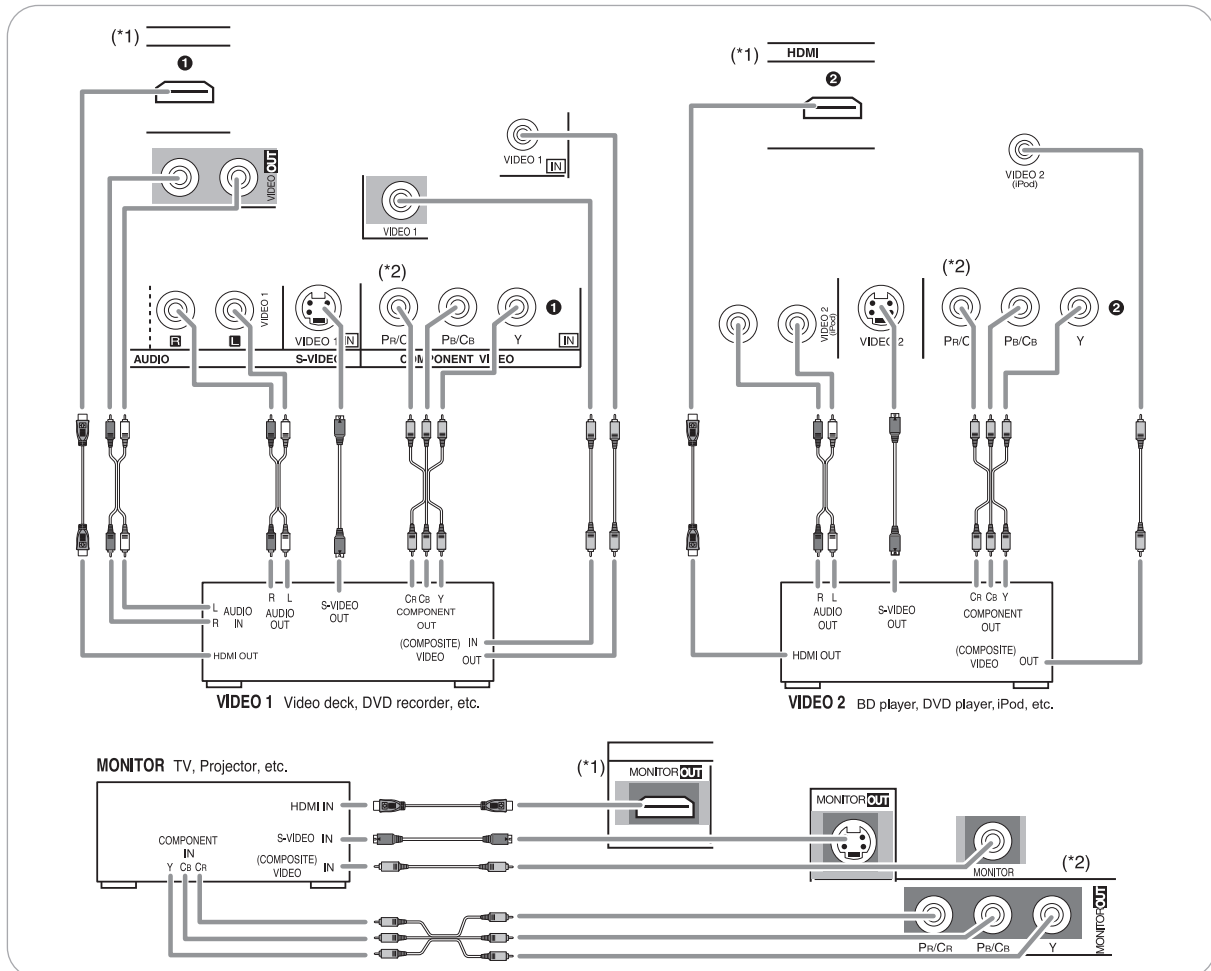

Continued**■ HDMI (High Definition Multimedia Interface) connection : (*1)**

- You can connect the source component (BD player, etc.) to the display component (TV, projector, etc.) through this receiver with using a commercially available HDMI cord.
- The HDMI connection can carry uncompressed digital video signals and digital audio signals.
- The HDMI video stream signals (video signals) are theoretically compatible with DVI-D. When connecting to a TV monitor, etc., equipped with DVI-D connector, it is possible to connect using a commercially available HDMI-DVI converter cord. Since the HDMI-to-DVI connection cannot carry any audio signals, you should make audio connections to play the audio signals on the component equipped with DVI-D connector. (For details, refer to the operating instructions of its.)
- If you connect the HDMI INs to your video components, it is easier to do so following the default settings.
- If your HDMI connection is different from the default setting, you should assign the HDMI INs you used with the "When selecting the HDMI Assign" procedure on page 52.
- The default settings are as follows :
HDMI 1 : VIDEO 1, HDMI 2 : VIDEO 2/iPod, HDMI 3 : VIDEO 3

■ Copyright protection system

- This unit supports HDCP (High-bandwidth Digital Contents Protection), technology to protect copyright of digital video signals against illegal duplication. HDCP must also be supported on the components connected to this unit.
- This unit is HDMI Ver. 1.3 compatible.
- HDMI, the HDMI logo and High-Definition Multimedia Interface are trademarks or registered trademarks of HDMI licensing LLC.

■ Notes :

- For stable signal transfer, we recommend using HDMI cords that are a maximum of 5 meters in length.
- Among the components that support HDMI, some components can control other components via the HDMI connector. However, this unit cannot be controlled by another component via the HDMI connector.
- The audio signals from the HDMI connector (including the sampling frequency and bit length) may be limited by the component that is connected.
- The video signals will not be output properly if a component incompatible with HDCP is connected.
- If the resolutions of the video signals which are output from the MONITOR OUTs and your monitor TV are not matched, the picture is not clear, natural or displayed. In this case, change the setting of the resolution on the source component (DVD player, etc.) to one which the monitor TV can handle. (For details, refer to the operating instructions of the source component.)
- When you want to enjoy only the picture on your TV, not the sound, you should set the HDMI Audio Output to Speaker not to output the digital audio signal from the HDMI MONITOR OUT of this receiver. (For details, refer to "When selecting the HDMI Audio Output" on page 41.)

■ Component video input default settings: (*2)

- If you connect the COMPONENT VIDEO INs to your video components, it is easier to do so following the default settings.
- If your component video connections are different from the default setting, you should assign the COMPONENT VIDEO INs you used with the "When selecting the Component Assign" procedure on page 52.
- The default settings are as follows:
COMPONENT IN 1 : VIDEO 1, COMPONENT IN 2 : VIDEO 2/iPod

3. CONNECTING AUDIO COMPONENTS

- When recording audio signals, connect the AUDIO IN/OUT jacks of "VIDEO 1" to audio recording equipment such as a tape deck, an MD recorder, etc.

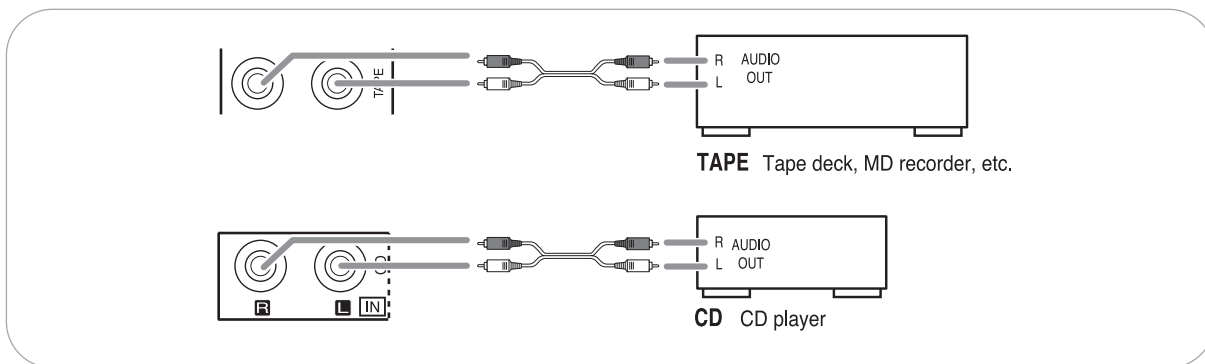

4. CONNECTING EXTERNAL IN'S

- Use these jacks to connect the corresponding outputs of a DVD player or external decoder, etc. that has 6, 7 or 8 channel analog audio outputs.
- In case of 6 or 7 channel outputs, do not connect both of the SURROUND BACK L and R inputs or the SURROUND BACK R input of this unit. (For details, refer to the operating instructions of the component to be connected.)

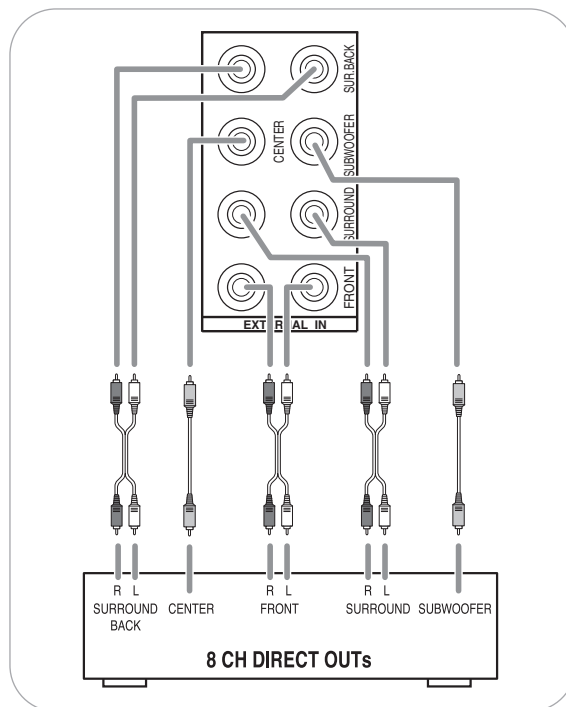

ENGLISH

5. CONNECTING DIGITAL IN'S AND OUT

- The OPTICAL and the COAXIAL DIGITAL OUTS of the components that are connected to this unit can be connected to these DIGITAL INs.
- A digital input should be connected to the components such as a CD player, DVD player, etc. capable of outputting DTS Digital Surround, Dolby Digital or PCM format digital signals, etc.
- If the component with OPTICAL IN jack is connected to the OPTICAL OUT jack of this unit, you can record the high quality sound of CDs, etc. without degradation.
- For details, refer to the operating instructions of the component connected.
- When making the COAXIAL DIGITAL connection, be sure to use a 75 Ω COAXIAL cord, not a conventional AUDIO cord.
- All of the commercially available optical fiber cords cannot be used for the equipment. If there is an optical fiber cord which cannot be connected to your equipment, consult your dealer or nearest service organization.

■ Notes :

- Be sure to make either a OPTICAL or a COAXIAL DIGITAL connection on each component. (You don't need to do both.)
- The digital audio signals input into the OPTICAL and the COAXIAL DIGITAL INs (, not the HDMI INs) can be output from the OPTICAL DIGITAL OUT.
- Depending on the digital audio signal format, some digital signals cannot be output from the OPTICAL OUT jack.

■ Digital input default settings

- If you connect the DIGITAL INs to your components, it is easier to do so following the default settings.
- If your DIGITAL connections are different from default settings, you should assign the DIGITAL INs you used with the "When selecting the Audio Assign" procedure on page 52.
- The default settings are as follows :
OPTICAL IN 1: VIDEO 1, OPTICAL IN 2: VIDEO 2/iPod, COAXIAL IN 1 : CD, COAXIAL IN 2 : F. AUX

6. CONNECTING SPEAKERS

- Be sure to connect speakers firmly and correctly according to the channel(left and right) and the polarity (+ and -). If the connections are faulty, no sound will be heard from the speakers, and if the polarity of the speaker connection is incorrect, the sound will be unnatural and lack bass.
- For installing the speakers, refer to "Speaker placement" on page 9.
- After installing the speakers, first adjust the speaker settings according to your environment and speaker layout. (For details, refer to "SETTING THE SPEAKER /ROOM EQ SETUP" on page 43.)

■ Surround back speakers

- When using only one surround back speaker, you should connect it to SURROUND BACK/MULTI LEFT channel.
- Because this receiver cannot drive the surround back speakers and the ROOM 2 speakers simultaneously, you should assign their power amplifier correctly depending on how to use them. (For details, refer to "CONNECTING ROOM 2 OUTS" on page 10 and "When selecting the AMP Assign" on page 41.)

■ Front Bi-Amp Connections.

- Some speakers are equipped with two sets of input terminals, for bi-amplification.
- If no other surround back speakers are used, you can connect the FRONT and the SURROUND BACK/MULTI channels to the bi-amp-capable speakers. (For details, refer to the operating instructions of your bi-amp-capable speakers.)
- To drive the bi-amp-capable speakers, you should assign the power amplifier to "Bi AMP".

■ Note :

- Before making bi-amp connections, remove the short-circuiting bars from the terminals of your speakers.



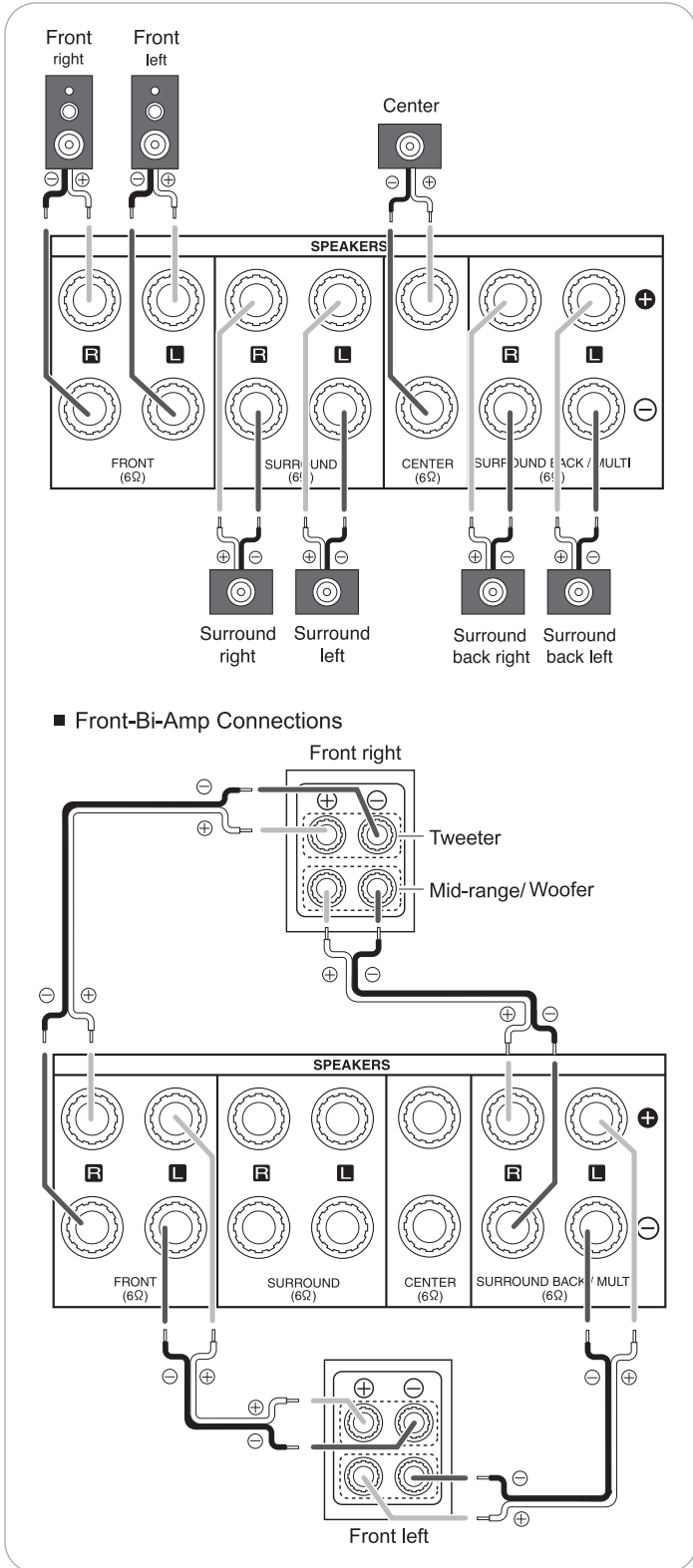

Caution :

- Be sure to use the speakers with the impedance of 6 ohms or above.
- Do not let the bare speaker wires touch each other or any metal part of this unit. This could damage this unit and/or the speakers.
- Never touch the speaker terminals while the AC input cord is connected to the wall AC outlet. Doing so could result in electric shocks.



Continued

■ Connecting speaker wire

<p>1. Strip away approx. 10 mm (3/8 inch) of wire insulation, then twist the wire ends tight.</p> 	<p>2. Loosen by turning the speaker terminal counter-clockwise.</p> 	<p>3. Insert the bare part of the wire.</p> 	<p>4. Tighten by turning it clockwise.</p> 
-------------------------------------------------------------------------------------------------------------------------------------------------------------------------------------	-------------------------------------------------------------------------------------------------------------------------------------------------------	--------------------------------------------------------------------------------------------------------------------------------	--------------------------------------------------------------------------------------------------------------------------------

Speaker placement

Ideal speaker placement varies depending on the size of your room and the wall coverings, etc. The typical example of speaker placement and recommendations are as follows :

■ Front left and right speakers and center speaker

- Place the front speakers with their front surfaces as flush with TV or monitor screen as possible.
- Place the center speaker between the front left and right speakers and no further from the listening position than the front speakers.
- Place each speaker so that sound is aimed at the location of the listener's ears when at the main listening position.

■ Surround left and right speakers

- Place the surround speakers approximately 1 meter (40 inches) above the ear level of a seated listener on the direct left and right of them or slightly behind.

■ Surround back left and right speakers

- Place the surround back speakers at the back facing the front at a narrower distance than front speakers.
- When using a single surround back speaker, place it at the rear center facing the front at a slightly higher position (0 to 20 cm) than the surround speakers.
- We recommend installing the surround back speaker(s) at a slightly downward facing angle. This effectively prevents the surround back channel signals from reflecting off the TV or screen at the front center, resulting in interference and making the sense of movement from the front to the back less sharp.

■ Subwoofer

- The subwoofer reproduces powerful deep bass sounds. Place a subwoofer anywhere in the front as desired.

■ Notes :

- When using a conventional TV, to avoid interference with the TV picture, use only magnetically shielded front left and right and center speakers.
- To obtain the best surround effects, the speakers except the subwoofer should be full range speakers.

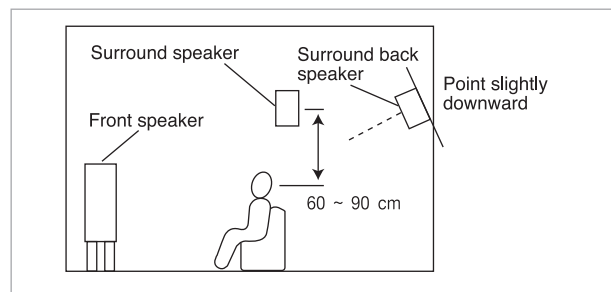
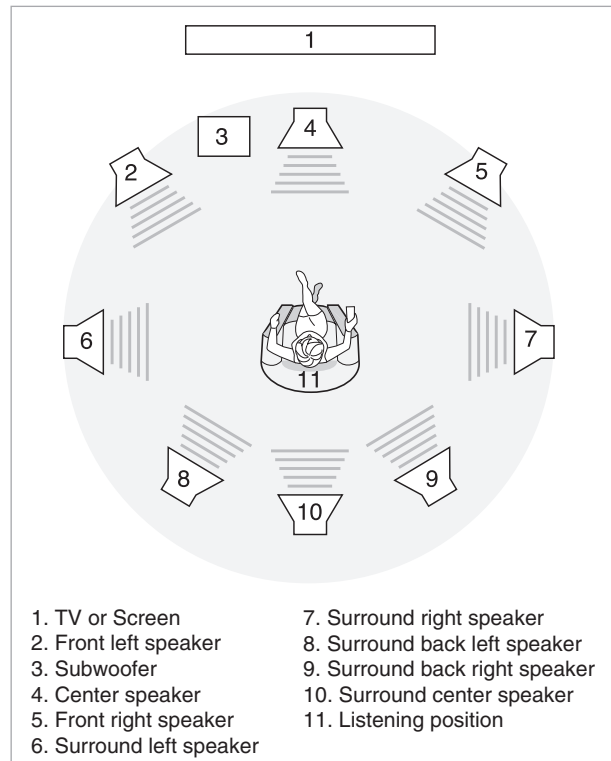

7. CONNECTING SUBWOOFER PRE OUT

- To emphasize the deep bass sounds, connect a powered subwoofer.

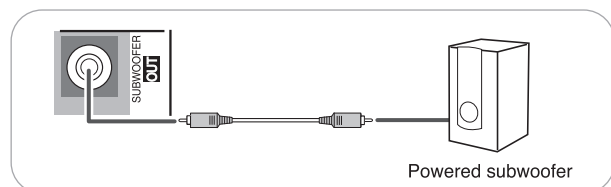

8. CONNECTING ROOM 2 OUTS

- ROOM 2 playback feature allows you to play a different program source in another room as well as one source in the main room at the same time.
- For ROOM 2 playback, connect the ROOM 2 OUT jacks to the amplifier, TV, etc. installed in another room, or connect the ROOM 2 speaker terminals to the speakers.
- Because this receiver cannot drive the surround back speakers and the ROOM 2 speakers simultaneously, you should assign their power amplifier correctly depending on how to use them. (For details, refer to "When selecting the AMP Assign" on page 41.)

■ Notes :

- To minimize hum or noise, use high quality connection cords.
- You cannot use the digital audio signal for ROOM 2 playback.

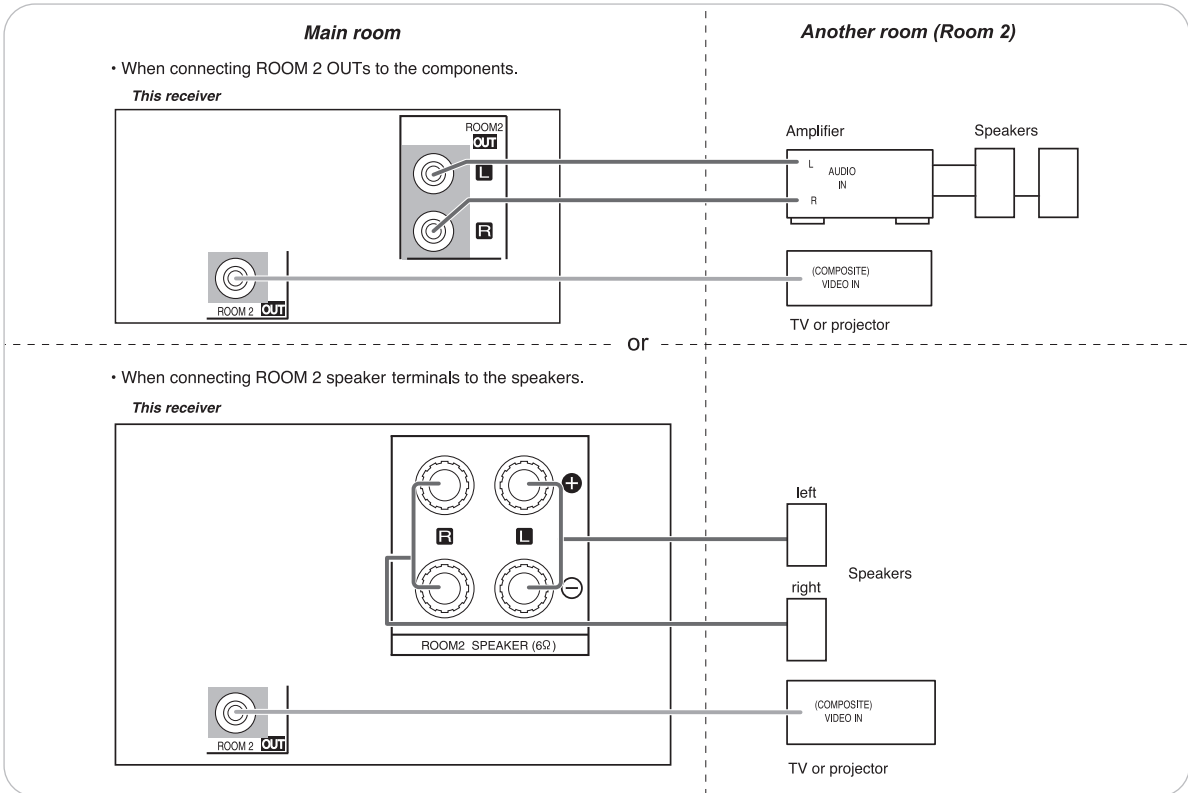

9. CONNECTING FOR SYSTEM CONTROL

- Connect this jack to the DIGI LINK-i jack of Sherwood iPod dock that allows you to control the iPod with the unit's remote control.

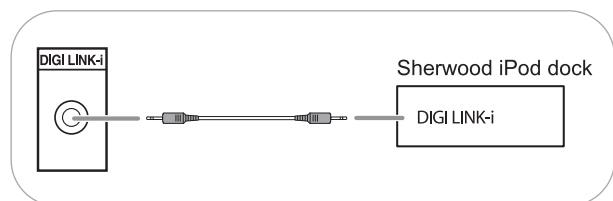

10. AC INPUT

- Plug this cord into a wall AC outlet.

Front Panel Controls

ENGLISH

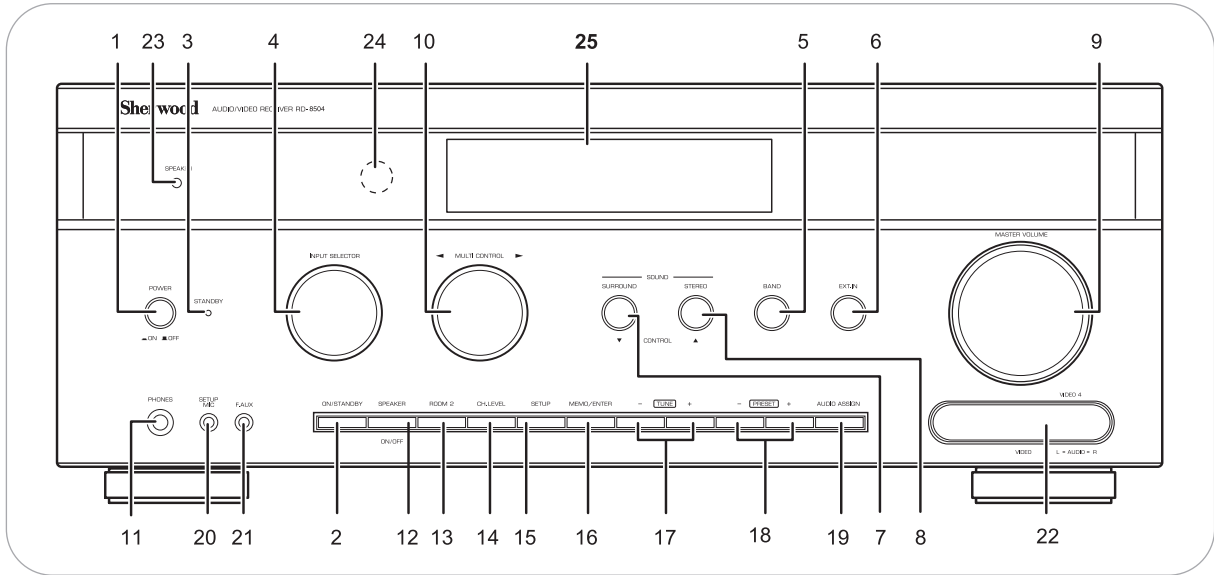

- | | |
|------------------------------------------------------------------------------------------------------------------------------------------------------------------------------------------------------------------------------------------------------------------------------------------------------------------------------------------------------------------------------------------------------------------------------------------------------------------------------------------------------------------------------------------------|----------------------------------------------------------------------------------------------------------------------------------------------------------------------------------------------------------------------------------------------------------------------------------------------------------------------------------------------------------------------------------------------------------------------------------------------------------------------------------------------------------------------------------------|
| <ul style="list-style-type: none"> 1. POWER switch 2. POWER ON/STANDBY button 3. STANDBY indicator 4. INPUT SELECTOR knob 5. BAND button 6. EXTERNAL IN button 7. SURROUND MODE/CONTROL DOWN(▼) button 8. STEREO/CONTROL UP(▲) button 9. MASTER VOLUME CONTROL knob 10. MULTI CONTROL knob(◀/▶) 11. HEADPHONE jack 12. SPEAKER button 13. ROOM 2 button 14. CHANNEL LEVEL button 15. SETUP button | <ul style="list-style-type: none"> 16. MEMORY/ENTER button 17. TUNING UP(+)/DOWN(-) buttons 18. PRESET UP(+)/DOWN(-) buttons 19. AUDIO ASSIGN button 20. SETUP MIC jack For details, see next page. 21. FRONT AUX IN jack For details, see next page. 22. VIDEO 4 IN jacks For details, see next page. 23. SPEAKER indicator 24. REMOTE SENSOR 25. FLUORESCENT DISPLAY For details, see next page. |
|------------------------------------------------------------------------------------------------------------------------------------------------------------------------------------------------------------------------------------------------------------------------------------------------------------------------------------------------------------------------------------------------------------------------------------------------------------------------------------------------------------------------------------------------|----------------------------------------------------------------------------------------------------------------------------------------------------------------------------------------------------------------------------------------------------------------------------------------------------------------------------------------------------------------------------------------------------------------------------------------------------------------------------------------------------------------------------------------|

■ FLUORESCENT DISPLAY

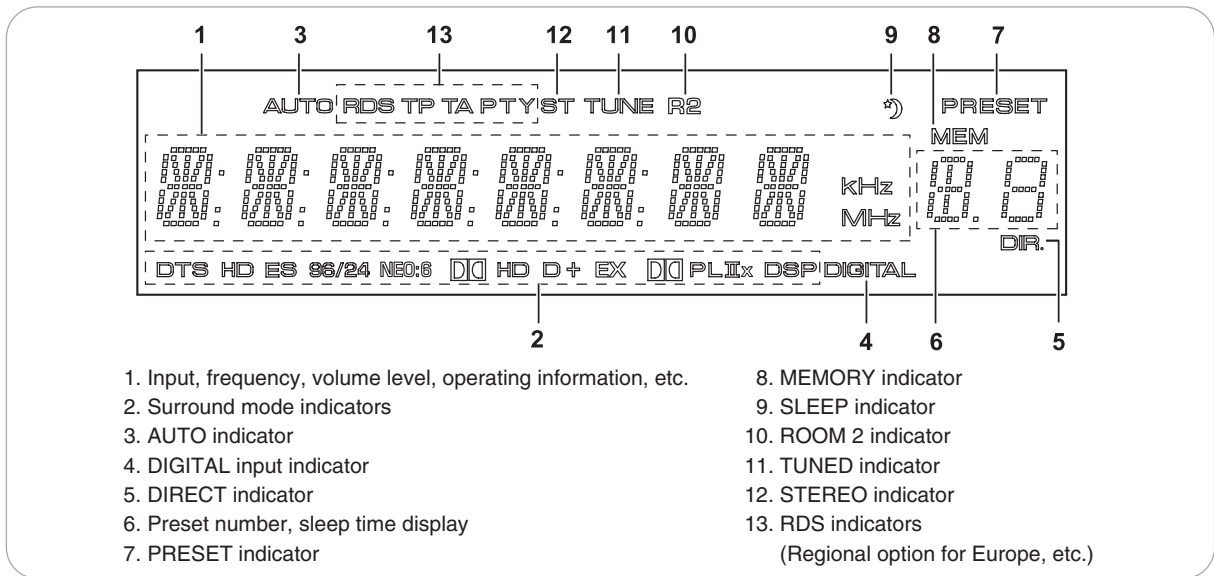

- | | |
|------------------------------------------------------------------------------------------------------------------------------------------------------------------------------------------------------------------------------------------------------------------------------------------------------------------------------|--------------------------------------------------------------------------------------------------------------------------------------------------------------------------------------------------------------------------------------------------------------------|
| <ul style="list-style-type: none"> 1. Input, frequency, volume level, operating information, etc. 2. Surround mode indicators 3. AUTO indicator 4. DIGITAL input indicator 5. DIRECT indicator 6. Preset number, sleep time display 7. PRESET indicator | <ul style="list-style-type: none"> 8. MEMORY indicator 9. SLEEP indicator 10. ROOM 2 indicator 11. TUNED indicator 12. STEREO indicator 13. RDS indicators (Regional option for Europe, etc.) |
|------------------------------------------------------------------------------------------------------------------------------------------------------------------------------------------------------------------------------------------------------------------------------------------------------------------------------|--------------------------------------------------------------------------------------------------------------------------------------------------------------------------------------------------------------------------------------------------------------------|

■ SETUP MIC JACK

- To use Auto Setup function, connect the supplied microphone to the SETUP MIC jack. (For details, refer to "When selecting the Auto Setup" on page 43.)

■ Notes:

- Because the microphone for Auto Setup is designed for use with this receiver, do not use a microphone other than the one supplied with this receiver.
- After you have completed the auto setup procedure, disconnect the microphone.

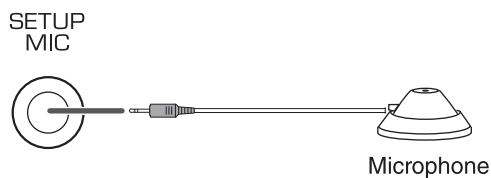

■ FRONT AUX IN JACK

- The FRONT AUX IN jack can be connected to additional audio components such as an MP3 player, etc.

■ Note :

- When connecting this jack to an MP3 player, etc., you should use the stereo mini cord, not a mono mini cord.

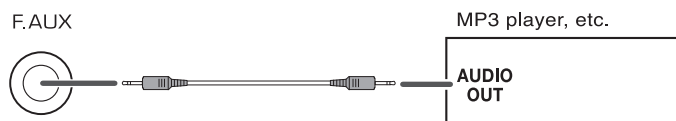

■ VIDEO 4 IN JACKS

- The VIDEO 4 IN jacks may be also connected to an additional video component such as a camcorder, a video game player, etc.

■ Note:

- When not using the VIDEO 4 IN jacks, cover them with the supplied cap.

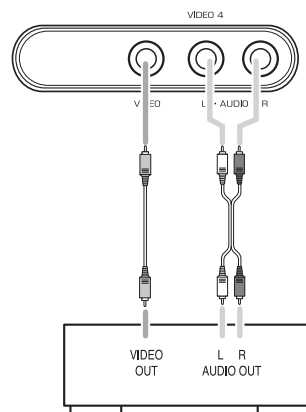

VIDEO 4 Camcorder, video game player, etc.

Universal Remote Controls

This universal remote control can operate not only this receiver but also most popular brands of audio and video components such as iPod docks, CD players, tape decks, TVs, BD/DVD players, satellite receivers, cable boxes, etc.

- To operate 7 components other than this receiver, you should enter the setup code for each component.
(For details, refer to "USING FUNCTIONS OF REMOTE CONTROL" on page 16.)
- The numbered buttons on the remote control have different functions in different device modes. For details, refer to "FUNCTION TABLE of the NUMBERED BUTTONS" on the next page.

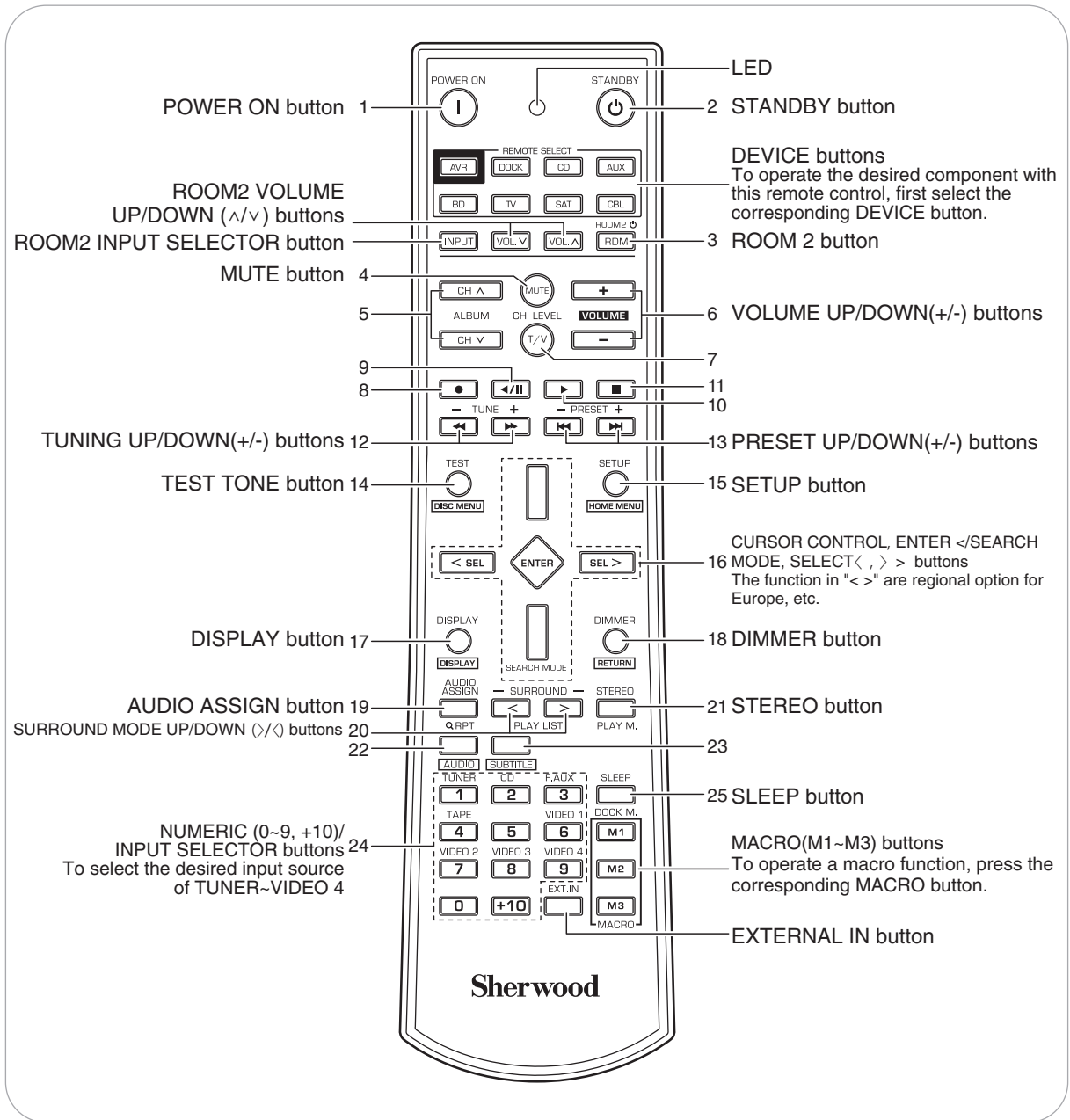

FUNCTION TABLE of the NUMBERED BUTTONS.

Device to be controlled Button symbol	DOCK	CD	AUX	BD	TV	SAT	CBL
	(for iPod Dock)	(for VCR)	(for CD player)	(for Tape deck)	(for BD/DVD player)	(for TV)	(for Satellite receiver)
1 POWER ON 	—	POWER ON	POWER ON	—	POWER ON	POWER ON	POWER ON
2 STANDBY 	—	STANDBY (POWER OFF)	STANDBY (POWER OFF)	—	STANDBY (POWER OFF)	STANDBY (POWER OFF)	STANDBY (POWER OFF)
3 	RANDOM	—	—	—	—	—	—
4 	—	MUTE	—	—	—	MUTE	MUTE
5 	ALBUM UP/DOWN (^/∨)	CHANNEL UP/DOWN (^/∨)	—	—	—	CHANNEL UP/DOWN (^/∨)	CHANNEL UP/DOWN (^/∨)
6 	—	VOLUME UP/DOWN (+/-)	—	—	—	VOLUME UP/DOWN (+/-)	VOLUME UP/DOWN (+/-)
7 	—	INPUT SELECTOR	—	—	INPUT SELECTOR	INPUT SELECTOR	INPUT SELECTOR
8 	—	RECORD	—	RECORD	—	—	—
9 	—	PAUSE	PAUSE	PAUSE	PAUSE	—	—
10 	PLAY/PAUSE	PLAY	PLAY	PLAY	PLAY	—	—
11 	—	STOP	STOP	STOP	STOP	—	—
12 	—	REWIND/FAST FORWARD (◀ / ▶)	—	REWIND/FAST FORWARD (◀ / ▶)	REVERSE/FORWARD SEARCH (◀◀ / ▶▶)	—	—
13 	REVERSE/FORWARD SKIP (◀◀ / ▶▶)	—	REVERSE/FORWARD SKIP (◀◀ / ▶▶)	—	REVERSE/FORWARD SKIP (◀◀ / ▶▶)	—	—
14 	MENU	—	—	—	DISC MENU	—	—
15 	—	—	—	—	HOME MENU	—	—
16 	CURSOR UP/DOWN	—	—	—	CURSOR UP/DOWN	—	—
	ENTER	—	—	—	ENTER	—	—
17 	—	—	—	—	DISPLAY	—	—
18 	—	—	—	—	RETURN	—	—
19 	REPEAT	—	—	—	REPEAT	—	—
20 	PLAY LIST UP/DOWN (>/<)	—	—	—	PLAY LIST UP/DOWN (>/<)	—	—
21 	—	—	—	—	PLAY MODE	—	—
22 	—	—	—	—	AUDIO	—	—
23 	—	—	—	—	SUBTITLE	—	—
24 	—	NUMERIC	NUMERIC	—	NUMERIC	NUMERIC	NUMERIC
25 	DOCK MODE	—	—	—	—	—	—

Notes :

- Some functions for each component may not be available or may work differently.
- Depending on other kinds of components that are available for each DEVICE button, some functions may not be available or may work differently, too.
- For details about functions, refer to the operating instructions of each component.

OPERATING COMPONENTS WITH REMOTE CONTROL

1. Enter the setup code for each component other than this receiver. For details, refer to "Entering a setup code" on page 16.
2. Turn on the component you want to operate.
3. Press the DEVICE button on the remote control corresponding to the component you wish to operate.
4. Aim the remote control at the REMOTE SENSOR of the component you wish to control and press the button corresponding to the operation you want.

- In such a case that some components do not have the REMOTE SENSOR which receives the remote signals, this remote control cannot operate them.

REMOTE CONTROL OPERATION RANGE

- Use the remote control within a range of about 7 meters (23 feet) and angles of up to 30 degrees aiming at the remote sensor.

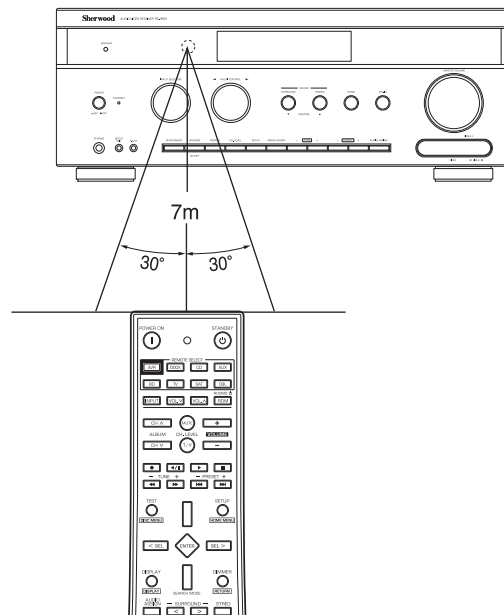

ENGLISH

LOADING BATTERIES

- When the remote control does not operate, the old batteries should be replaced. In this case, load new batteries within several minutes after removing old batteries.
- If the batteries are removed or have been exhausted for a longer period of time, memorized contents will be cleared. Should this happen, you should memorize them again.

1. Remove the cover.

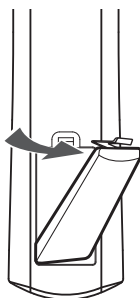

2. Load two batteries ("AAA" size, 1.5V) matching the polarity.



- Remove the batteries when they are not used for a long time.
- Do not use the rechargeable batteries (Ni-Cd type).
- Be sure to use alkaline batteries.

USING FUNCTIONS OF REMOTE CONTROL

- This remote control can control up to 8 different components.
- Before operating audio and video components other than this receiver with using this remote control, the setup code for each component should be entered.
- For system remote control operation, "000" was stored previously in the memory of the device button "DOCK" for Sherwood iPod dock, "CD" for Sherwood CD player, "BD" for Sherwood BD/DVD player and "TV" for Sherwood TV respectively as its factory setup code. So, you don't need to enter its code for each Sherwood component except in such a case that its code does not work.

Entering a setup code

1. Turn on the component you want to operate.
2. Find the setup codes according to the type and the brand name of your component, referring to "Setup Code Table" on page 61.
3. Press and hold down both the ENTER button and the desired one of the DEVICE buttons for more than 1 seconds.

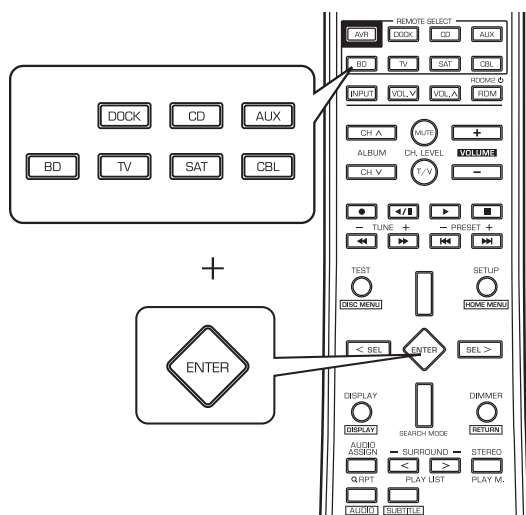

- The LED will flicker once.

■ Note :

- The "AVR" button is unavailable for the audio components other than this receiver.

4. Enter a 3 digit code, aiming the remote control at the remote sensor on the component.

Example: When entering "001".

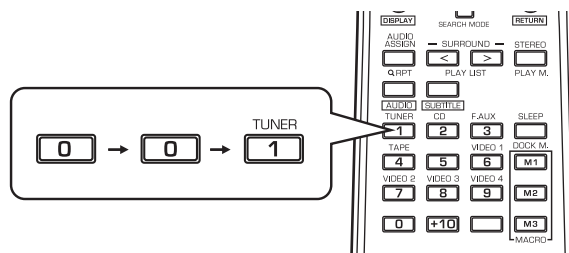

- If entering is performed successfully, the LED will flicker twice.
- To be sure that the setup code is correct, press the POWER ON (or STANDBY) button. If your component is turned off, the setup code is correct.
- When your component is not turned off, repeat the above steps 2 to 4, trying each code for your component until you find one that works.

■ Notes:

- If the LED did not flicker twice, then repeat the above steps 3 to 4 and try entering the same code again.
- Manufacturers may use different setup codes for the same product category. For that reason, it is important that you check to see if the code you have entered operates as many controls as possible. If only a few functions operate, check to see if another code will work with more buttons.

5. Repeat the above steps 1 to 4 for each of your components.

Using a punch-through function

This remote control may be programmed to operate either the AUDIO volume punch-through or the TV volume and/or TV channel punch-through in conjunction with any of the 8 components controlled by this remote control.

For example, since this receiver will likely be used as the sound system while watching TV, you may want to adjust this receiver's volume although this remote control is set to control the TV.

- When programming this remote control for the AUDIO volume punch-through, press and hold down both "AVR" button and "VOLUME +" button for more than 1 second.

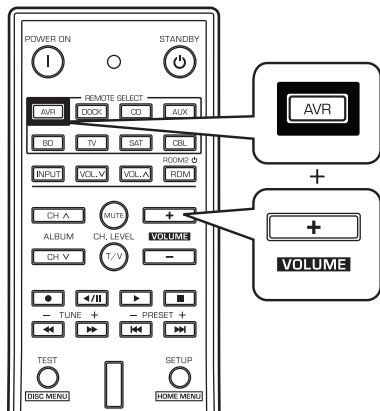

- If programming is performed successfully, the SET LED will flicker twice.
- When you want either TV volume or TV channel punch-through, press and hold down both "TV" button and either "VOLUME +" or "CH ^" button for more than 1 second.

■ Note :

- If you use one of AUDIO and TV volume punch-through functions, you cannot use the other.

■ Removing a punch-through function

- When removing the AUDIO volume punch-through, press and hold down both "AVR" button and "VOLUME -" button for more than 1 second.

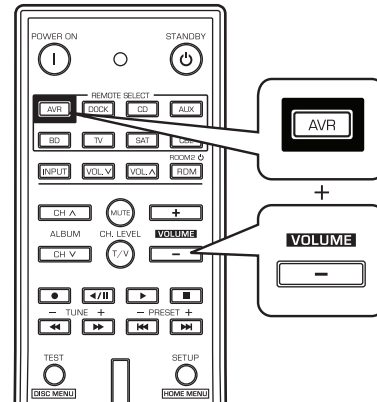

- If removing is performed successfully, the LED will flicker twice.
- When you want to remove either TV volume or TV channel punch-through, press and hold down both "TV" button and either "VOLUME -" or "CH ∇" button for more than 1 second.

■ Removing all punch-through functions

Press and hold down both "AVR" button and "AUDIO ASSIGN" button for more than 1 second.

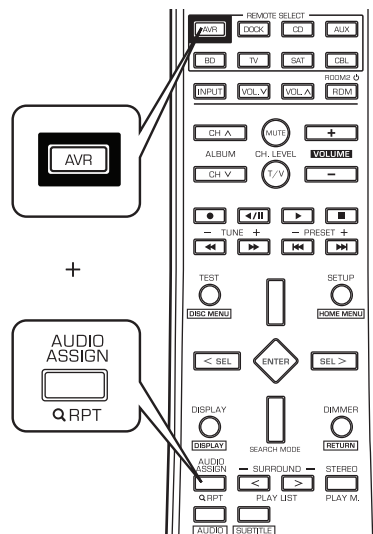

- If removing all punch-through functions is performed successfully, the LED will flicker twice.

Programming a macro function

- The macro function enables you to program a series of button operations (up to 10) on this remote control into a single button.
- You can store up to three separate macro command sequences into “M1”, “M2” and “M3” buttons.

1. Press and hold down both “ENTER” button and one of three NUMERIC buttons (“1” ~ “3”) corresponding to “M1” ~ “M3” buttons for more than 1 second.

Example: When programming a series of button operations into “M1” button.

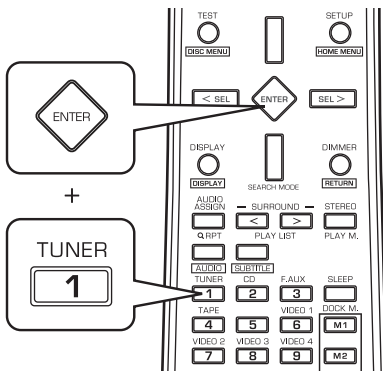

- If the macro mode is entered, the LED will flicker once.

2. Press the operation buttons you want to program in order.

■ Note :

You should press the corresponding DEVICE buttons before pressing each operation button.
Example: When playing a BD on the BD player connected to VIDEO 2 jacks of this receiver.

- ①. Press “AVR” button to control this receiver.
- ②. Press “POWER ON” button to turn this receiver on.
- ③. Press “AVR” button to control this receiver.
- ④. Press “VIDEO 2(7)” button to select the desired input source.
- ⑤. Press “BD” button to control the BD player.
- ⑥. Press “POWER ON” button to turn the BD player on.
- ⑦. Press “BD” button to control the BD player.
- ⑧. Press “▶” button to start playback.

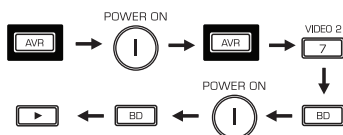

3. Press “ENTER” button.

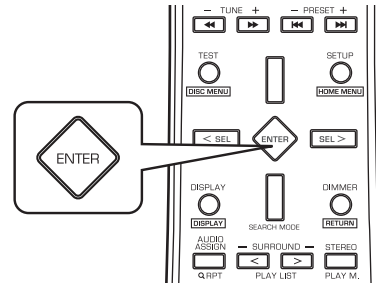

- If the programming is performed successfully, the LED will flicker twice.

■ To remove a macro program

- When removing a macro program, perform the above steps 1 and 3, but ignore the step 2.

■ To change a macro program

- When a new macro program is stored into a MACRO button with performing the above steps 1 to 3, the previous macro program is cleared from the memory of the MACRO button.

Operating a macro function

- Aim the remote control at the REMOTE SENSORS of the components to be controlled and press the MACRO button you want.

Example: When pressing “M1” button.

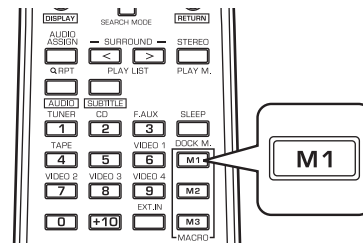

■ Notes:

- The codes programmed into a MACRO button will be transmitted at an interval of 0.5 seconds. However, some components may not be able to complete one operation in 0.5 seconds and may miss the next code. In this case, the macro function cannot control the corresponding components correctly.
- Be sure to use the remote control within the remote control operation range of the components.
- Depending on the operation status of the components, etc., the macro function cannot control the corresponding components correctly.

Operations

Notes:

- Before operating this receiver with the supplied remote control, refer to "Universal Remote Controls" on page 13 for details about operation.
- Before operating this receiver, first set this unit as desired for optimum performance, doing the OSD menu setting procedures. (For details, refer to "OSD Menu Settings" on page 36.)

LISTENING TO A PROGRAM SOURCE

Before operation

- Enter the standby mode.
- The STANDBY indicator lights up. This means that the receiver is not disconnected from the AC mains and a small amount of current is retained to support the operation readiness.
- To switch the power off, push the POWER switch again. Then the power is cut off and the STANDBY indicator goes off.



1. In the standby mode, turn the power on.

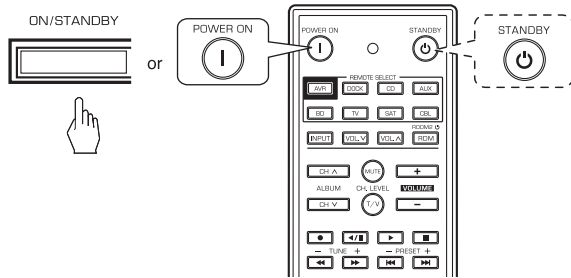

- Each time the POWER ON/STANDBY button on the front panel is pressed, the receiver is turned on to enter the operating mode (the STANDBY indicator goes off) or off to enter the standby mode (the STANDBY indicator lights up).
- On the remote control, press the POWER ON button to enter the operating mode or press the STANDBY button to enter the standby mode.

2. Switch the speakers on.

- Then the SPEAKER indicator lights up and the sound can be heard from the speakers connected to the speaker terminals.
- When using the headphones for private listening, press the SPEAKER button again to switch the speakers off.

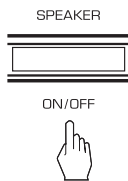

3. Select the desired input source.

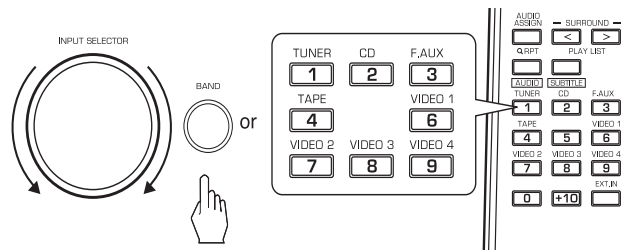

- Each time the INPUT SELECTOR knob on the front panel is rotated, the input source changes as follows:
 → TUNER ↔ CD ↔ TAPE ↔ F.AUX ↔ VIDEO 1
 (Frequency display)
 → VIDEO 4 ↔ VIDEO 3 ↔ V2/IPOD
- Each time the BAND button (or the TUNER button on the remote control) is pressed, the band changes as follows:
 → FM ST → FM MONO → AM

When selecting the EXTERNAL IN as desired,

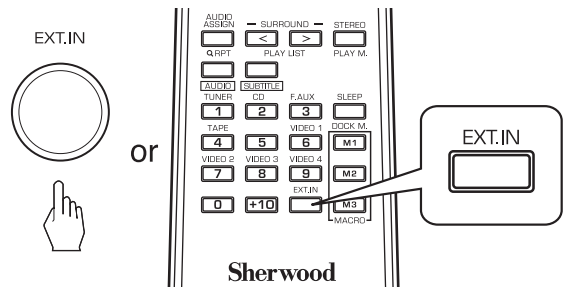

- Depending on the power amplifier setting for the surround back channels and the surround back speaker setting, "EXT. IN" is displayed and 8(7/6) separate analog signals from the component connected to this input pass through the volume circuits only and can be heard from your speakers.
- Select the desired input source to cancel the external in function.
- These analog signals can be heard only, not recorded.

When CD, F.AUX, VIDEO 1~ 4, EXT.IN is selected as an input source

- If the Audio Mode is set to the mode other than "Digital" for the corresponding input source on the INPUT SETUP menu, you cannot hear the sound from the selected digital input. (For details, refer to "SETTING THE INPUT SETUP" on page 51.)

4. Press the AUDIO ASSIGN button.

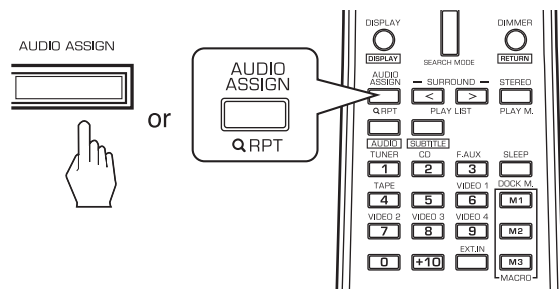

- "AUD ~ " is displayed for several seconds.
- "AUD ~ " disappears, press the AUDIO ASSIGN button again.

5. Select the desired of the digital inputs connected while displaying "AUD ~ ".

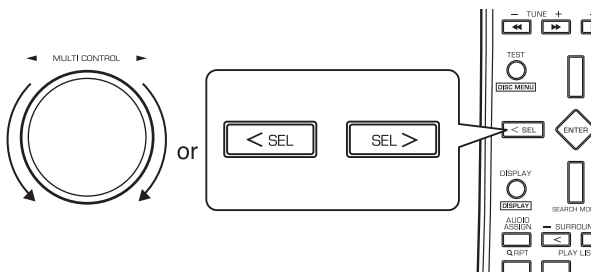

- Each time the MULTI CONTROL knob is rotated or the CURSOR LEFT/RIGHT buttons are pressed, the corresponding input is selected as follows :

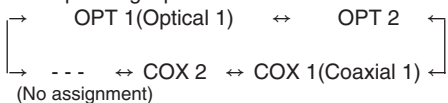

■ Notes:

- When the selected digital input is not connected, the digital input flickers and no sound will be heard.
- The selected digital input is automatically assigned to the corresponding input source on the INPUT SETUP menu. (For details, refer to "SETTING THE INPUT SETUP" on page 51.)
- The sound from the component connected to the selected digital input can be heard regardless of the selected input source.

6. Operate the selected component for playback.

- When playing back the program sources with surround sound, refer to "ENJOYING SURROUND SOUND" on page 23.

7. Adjust the (overall) volume.

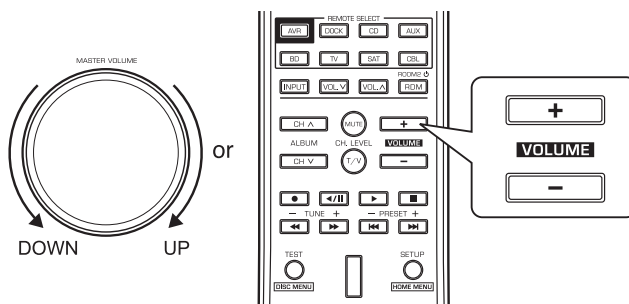

Muting the sound

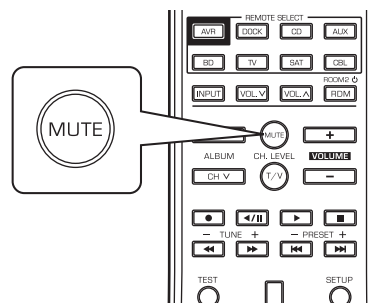

- "MUTE" flickers.
- To resume the previous sound level, press it again.

Listening with headphones

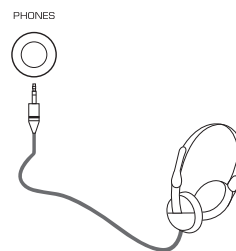

- Ensure that the SPEAKER button is set to off.
- When listening to a DTS or Dolby Digital program source, if the headphones are plugged in and the SPEAKER button is set to off, it enters the 2CH downmix mode automatically. (For details, refer to "2CH downmix mode" on page 24.)

■ Note:

- Be careful not to set the volume too high when using headphones.

SURROUND SOUND

- This receiver incorporates a sophisticated Digital Signal Processor that allows you to create optimum sound quality and sound atmosphere in your personal Home Theater.

Surround modes

■ DTS Digital Surround

DTS Digital Surround(also called simply DTS) supports up to 5.1 discrete channels and uses less compression for high fidelity reproduction. Use it with DVDs and CDs bearing the DTS logo.

■ DTS-ES™ Discrete 6.1

This is a 6.1 channel discrete digital audio format adding a surround back channel to the DTS digital surround sound. The seven totally separate audio channels provide better spatial imaging and 360 degrees sound localization, perfect for sounds that pan across the surround channels. Use it with DVDs bearing the DTS-ES logo, especially those with a DTS-ES Discrete sound track.

■ DTS - ES™ Matrix 6.1

This is a 6.1 channel discrete digital audio format inserting a surround back channel to the DTS digital surround sound through matrix encoding. Use it with DVDs bearing the DTS-ES logo.

■ DTS Neo : 6™ surround

DTS Neo : 6 is a matrix decoding technology for achieving 7.1 channel surround playback with 2 channel sources. It includes "DTS Neo : 6 Cinema" suited for playing movies and "DTS Neo : 6 Music" suited for playing music.

■ DTS 96/24

This is high resolution DTS with a 96 kHz sampling rate and 24 bit resolution, providing superior fidelity. Use it with DVDs bearing the DTS 96/24 logo.

■ DTS-HD High Resolution Audio

Developed for use with HDTV, including the new video disc formats Blu-ray and HD DVD, this is the latest multi-channel audio format from DTS. It supports up to 7.1 channels with 96 kHz/24 bit sampling rate and signal resolution.

■ DTS-HD Master Audio

Designed to take full advantage of the additional storage space offered by the new Blu-ray and HD DVD disc formats, this new DTS format offers up to 7.1 discrete channels of uncompressed digital audio with 96 kHz/24 bit sampling rate and signal resolution.

Manufactured under license under U.S. Patent #'s: 5,451,942; 5,956,674; 5,974,380; 5,978,762; 6,226,616; 6,487,535; 7,212,872; 7,333,929; 7,392,195; 7,272,567 & other U.S. and worldwide patents issued & pending.

DTS is a registered trademark and the DTS logos, Symbol, DTS-HD and DTS-HD Master Audio are trademarks of DTS, Inc.

© 1996-2008 DTS, Inc. All Rights Reserved.

■ Dolby Digital

Dolby Digital is the multi-channel digital signal format developed by Dolby Laboratories. Discs bearing the Dolby Digital logo includes the recording of up to 5.1 channels of digital signals. This will put you right in the middle of the action, just like being in a movie theater or concert hall.

■ Dolby Digital EX

This mode expands 5.1-channel sources for 6.1/7.1 channel playback. It's especially suited to Dolby Digital EX soundtracks that include a matrix-encoded surround back channel. The additional channel adds an extra dimension and provides an enveloping surround sound experience, perfect for rotating and fly-by sound effects.

■ Dolby Digital Plus

Developed for use with HDTV, including the new video disc formats Blu-ray and HD DVD, this is the latest multichannel audio format from Dolby. It supports up to 7.1 channels with 48 kHz/24-bit sampling rate and signal resolution.

■ Dolby TrueHD

Designed to take full advantage of the additional storage space offered by the new Blu-ray and HD DVD disc formats, this new Dolby format offers up to 7.1 discrete channels of lossless audio performance with 96 kHz/24 bit sampling rate and signal resolution.

■ Dolby Pro Logic Ix surround

This mode expands any 2-channel source for 7.1-channel playback. It provides a very natural and seamless surround sound experience that fully envelopes the listener. As well as music and movies, video games can also benefit from the dramatic spatial effects and vivid imaging. It includes "Dolby Pro Logic Ix Movie" suited for playing movies, "Dolby Pro Logic Ix Music" suited for playing music and "Dolby Pro Logic Ix Game" suited for playing games.

■ Dolby Pro Logic II surround

If you are not using any surround back speakers, Dolby Pro Logic II surround will be used instead of Dolby Pro Logic Ix surround. It includes Dolby Pro Logic II Movie, Dolby Pro Logic II Music and Dolby Pro Logic II Game like Dolby Pro Logic Ix surround.

Manufactured under license from Dolby Laboratories. Dolby and the double-D symbol are registered trademarks of Dolby Laboratories.

- The following modes apply conventional 2-channel signals such as digital PCM or analog stereo signals to high performance Digital Signal Processor to recreate sound fields artificially. Select one of the 7 provided surround modes according to the program source you want to play.

■ Theater

This mode provides the effect of being in a movie theater when watching a play.

■ Hall

This mode provides the ambience of a concert hall for classical music sources such as orchestral, chamber music or an instrumental solo.

■ Stadium

This mode provides the expansive sound field to achieve the true stadium effect when watching baseball or soccer games.

■ Room

This mode provides the sound field of a house with a low ceiling and hard walls for jazz music.

■ Panorama

This mode provides a dynamic and broad sound space to heighten the overall impact of the sound track.

■ Classic

This mode provides the acoustic effects of a large concert hall for classical music.

■ Multi CH Stereo

This mode is designed for playing background music. The front, surround and surround back channels create a stereo image that encompasses the entire area.

- When using the EXTERNAL INs to play back the sound from the additional multi-channel decoder for surround sound, you can enjoy the corresponding surround sound, too. (For details, refer to the operating instructions of the component to be connected.)

For your reference, the sound from each channel can be reproduced according to the surround modes as follows:

Modes	Channels	FRONT L/R	CENTER	SURROUND L/R	SURROUND BACK L/R	SUBWOOFER
DTS-HD HIGH RESOLUTION AUDIO/MASTER AUDIO		O	O	O	O/—	O
DTS, DTS 96/24		O	O	O	—	O
DTS ES DISCRETE/MATRIX		O	O	O	O	O
DTS NEO: 6 CINEMA/MUSIC		O	O	O	O	—(*)
DOLBY DIGITAL PLUS / DOLBY TRUEHD		O	O	O	O/—	O
DOLBY DIGITAL		O	O	O	—	O
DOLBY DIGITAL EX		O	O	O	O	O
DOLBY PRO LOGIC IIx MOVIE/MUSIC/GAME		O	O	O	O	O
DOLBY PRO LOGIC II MOVIE/MUSIC/GAME		O	O	O	—	O
MULTI PCM		O	O	O	O/—	O
Other Surrounds		O	O	O	O	—(*)
STEREO		O	—	—	—	—(*)
EXTERNAL IN		O	O	O	O	O

(*): Depending on the subwoofer setting, the sound from the subwoofer channel may be reproduced.

- Depending on the speaker settings and the number of the encoded channels, etc., the sound from the corresponding channels cannot be reproduced. (For details, refer to "SETTING THE SPEAKER / ROOM EQ SETUP" on page 43.)

ENJOYING SURROUND SOUND

Notes:

- Before surround playback, first perform the speaker setup procedure, etc. on the OSD menu for optimum performance. (For details, refer to "SETTING THE SPEAKER / ROOM EQ SETUP" on page 43.)
- When playing digital signals from the Dolby Digital program source or selecting the surround mode such as Dolby Pro Logic II /Dolby Pro Logic IIx Music mode, you can adjust their parameters for optimum surround effect. (For details, refer to "SETTING THE SOUND PARAMETER" on page 57.)
- When the EXTERNAL IN is selected as an input source, if the Audio Mode is set to "Analog", the surround modes cannot be selected. (For details, refer to "When selecting the Audio Mode" on page 53.)

Depending on how to select a surround mode, select the auto surround mode or the manual surround mode.

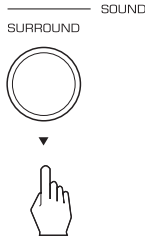

- Each time this button is pressed, the mode changes as follows :
 Auto surround mode : The optimum surround mode will be automatically selected depending on the signal format being input. ("AUTO" lights up.)
- Manual surround mode : You can select the desired of different surround modes selectable for the signal being input with using the MULTI CONTROL knob or the SURROUND MODE UP/DOWN (> /<) buttons. ("AUTO" goes off.)

Notes :

- Even when the auto surrounding mode is selected and the same type of digital signal format is being input, the optimum surround mode may vary depending on whether the speaker type is set to "NO" or not.
- When the auto surround mode is selected, the surround modes other than the optimum surround mode cannot be selected.

- When selecting the manual surround mode with pressing the SURROUND MODE button on the front panel. Select the desired surround mode.

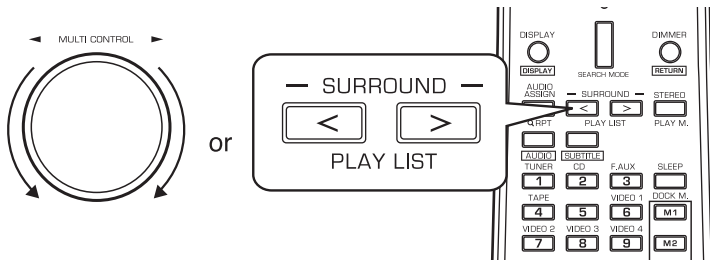

- Each time the MULTI CONTROL knob is rotated or the SURROUND MODE UP / DOWN (> /<) buttons are pressed, the surround mode changes depending on the input signal format as follows :

Signal format being input	Selectable surround mode
Dolby Digital Plus sources	DOLBY DIGITAL +
Dolby TrueHD sources	DOLBY TRUEHD
Dolby Digital EX 6.1 channel sources, Dolby Digital 5.1 channel sources	<DOLBY DIGITAL EX, DOLBY D + PLIIx MUSIC>, (DOLBY D + PLIIx MOVIE), DOLBY DIGITAL
Dolby Digital 2 channel sources	<DOLBY PLIIx MOVIE, DOLBY PLIIx MUSIC, DOLBY PLIIx GAME>, [DOLBY PLII MOVIE, DOLBY PLII MUSIC, DOLBY PLII GAME]
DTS-HD High Resolution Audio sources	DTS-HD HI RES
DTS-HD Master Audio sources	DTS-HD MSTR
DTS ES Discrete/Matrix 6.1 channel sources	<corresponding DTS ES mode, DTS + PLIIx MUSIC>, (DTS + PLIIx MOVIE), DTS
DTS sources, DTS 96/24 sources	corresponding DTS mode, <DTS + NEO:6, DTS + PLIIx MUSIC>, (DTS + PLIIx MOVIE)
PCM (multi-channel) sources*	MULTI PCM, <DOLBY PLIIx MOVIE, DOLBY PLIIx MUSIC>
PCM (2 channel) sources, Analog stereo sources	<DOLBY PLIIx MOVIE, DOLBY PLIIx MUSIC, DOLBY PLIIx GAME>, [DOLBY PLII MOVIE, DOLBY PLII MUSIC, DOLBY PLII GAME], NEO:6 CINEMA, NEO:6 MUSIC, THEATER, HALL, STADIUM, ROOM, PANORAMA, CLASSIC, MULTI-CH STEREO

- Depending on surround back speaker setting, some surround modes can be selected or not as follows:
 < > : Possible only when surround back speaker is not set to "No".
 [] : Possible only when surround back speaker is set to "No".
 () : Possible only when surround back speaker is set to "2 Channel".
 * : Depending on the signal format being input, the Dolby Pro Logic IIx modes may not be selected.

ENGLISH

Continued

■ To cancel the surround mode for stereo operation

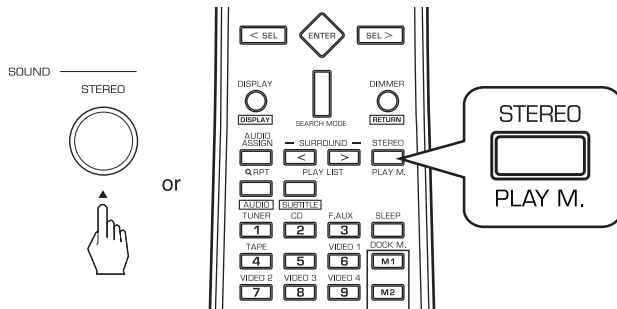

- Depending on the signal format which is being input, either the stereo mode or the 2CH downmix mode is selected.
- To cancel either the stereo mode or the 2CH downmix mode, select the surround mode with using the MULTI CONTROL knob on the front panel or the SURROUND MODE UP/DOWN (> /<) buttons on the remote control.

■ 2CH downmix mode

- This mode allows the multi-channel signals encoded in DTS or Dolby Digital format, etc. to be mixed down into 2 front channels and to be reproduced through only two front speakers or through headphones.
- When the SPEAKER button is set to off to listen with headphones while playing the multi-channel digital signals from DTS or Dolby Digital sources, etc., it will enter the 2CH downmix mode automatically.

Adjusting each channel level with test tone

- The volume level of each channel can be adjusted easily with the test tone function.
- **Note** : When the SPEAKER button is set to off, the test tone function does not work.

1. Enter the test tone mode.

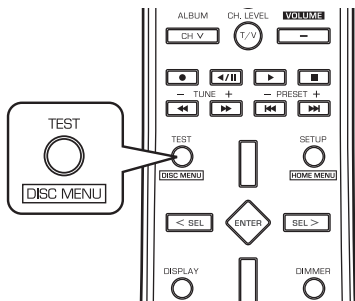

- The test tone mode is displayed and will be heard from the speaker of each channel for 2 seconds as follows:

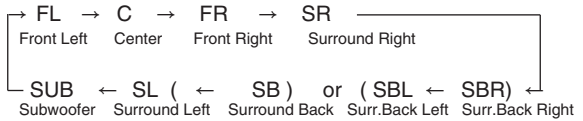

- When the speaker setting is "No", the test tone of the corresponding channel is not available.
- () : Possible depending on whether the surround back channel is set to "2 Channel" or "1 Channel (Left)".

2. At each channel, adjust the level as desired until the sound level of each speaker is heard to be equally loud.

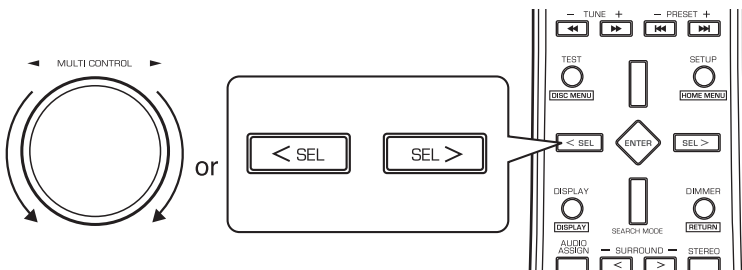

- You can select the desired channel with pressing the CONTROL UP/DOWN buttons or the CURSOR UP/DOWN buttons.

3. Cancel the test tone function.

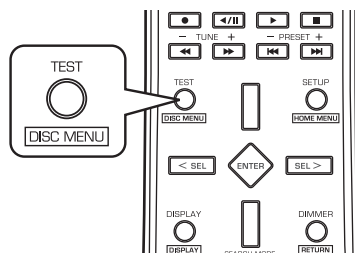

Adjusting the current channel level

- After adjusting each channel level with test tone, adjust the channel levels either according to the program sources or to suit your tastes.
- You can adjust the current channel levels as desired. These adjusted levels are just memorized into user's memory ("CAL"), not into preset memory("MOVIE" for movie source, "MUSIC" for music source).

1. Press the CHANNEL LEVEL button.

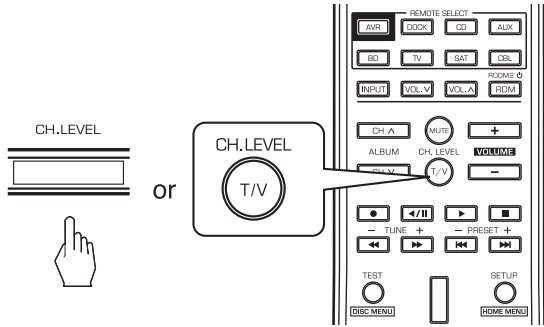

- Then the memory mode ("CAL", "MOVIE", etc) is displayed for several seconds.
- When the memory mode or channel level disappears, press this button again.

2. Select the desired channel.

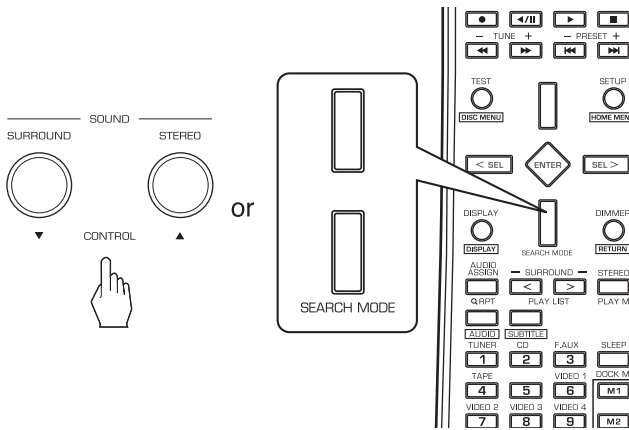

- Each time these buttons are pressed, the corresponding channel is selected as follows:
 → CAL (or MOVIE, etc.) ↔ FL ← C ← FR ← SR ←
 <LFE> ↔ SUB ↔ SL(↔SB) or (↔SBL ↔ SBR)
 DTS LFE or Dolby Digital LFE

() : Possible depending on whether the surround back channel is set to "2 Channel" or "1 Channel (Left)".
 < > : Possible only when the digital signals from Dolby Digital, DTS, Dolby TrueHD or DTS HD program sources that include LFE signal are input.

- Depending on the speaker settings("No", etc.) and surround mode, etc., some channels cannot be selected.
- When the SPEAKER button is set to off, only the Front Left, Front Right(and LFE) channels can be selected.

3. Adjust the level of the selected channel as desired.

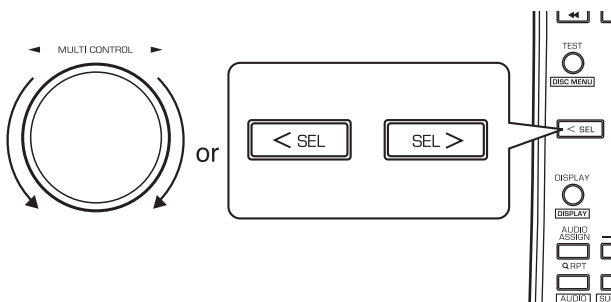

- The LFE level can be adjusted within the range of -10 ~ 0 dB and other channel levels within the range of -15 ~ +15 dB.
- In general, we recommend the LFE level to be adjusted to 0 dB.(However, the recommended LFE level for some early DTS software is -10 dB.) If the recommended levels seem too high, lower the setting as necessary.

4. Repeat the above steps 2 and 3 to adjust each channel level.

ENGLISH

Memorizing the adjusted channel levels

- You can memorize the adjusted channel levels into preset memory("MOVIE", "MUSIC") and recall the memorized whenever you want.

1. After performing the steps 1~4 in "Adjusting the current channel level" procedure on page 25, press the (MEMORY)/ENTER button.

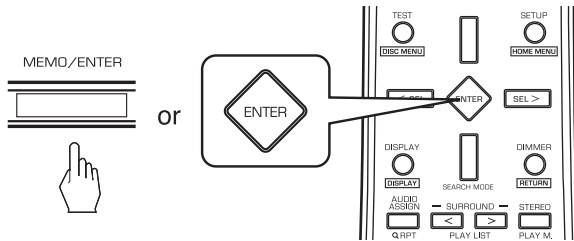

- The "MOVIE" flickers for several seconds.

2. Select the desired one of MOVIE and MUSIC.

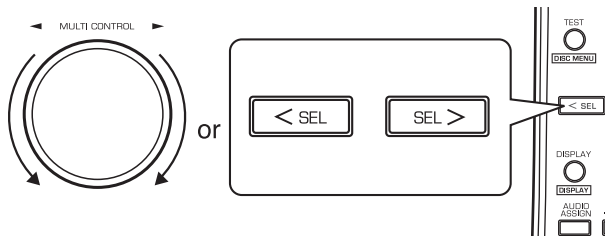

- If the preset memory disappears, perform the above step 1 again.

3. Confirm your selection.

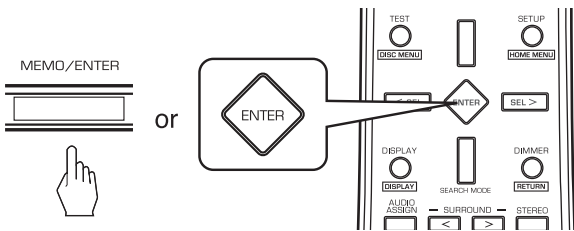

- The adjusted channel levels have now been memorized into the selected memory.

Recalling the memorized channel levels

1. Press the CHANNEL LEVEL button.

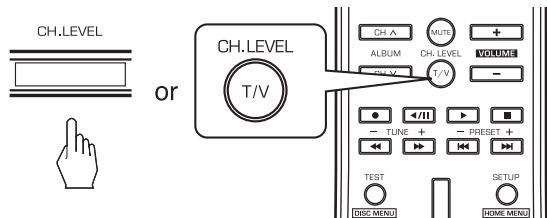

- "CAL" (or "MOVIE", etc.) is displayed for several seconds.
- If the memory mode disappears, press this button again.

2. Select the desired one of MOVIE and MUSIC.

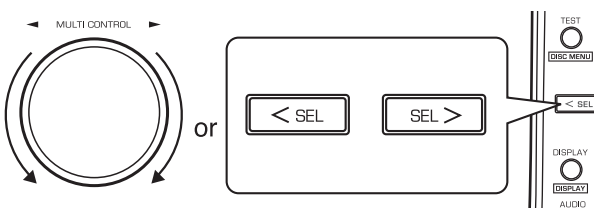

- Then the channel levels memorized into the selected preset memory are recalled.

LISTENING TO RADIO BROADCASTS

Auto tuning

1. Select the desired band.

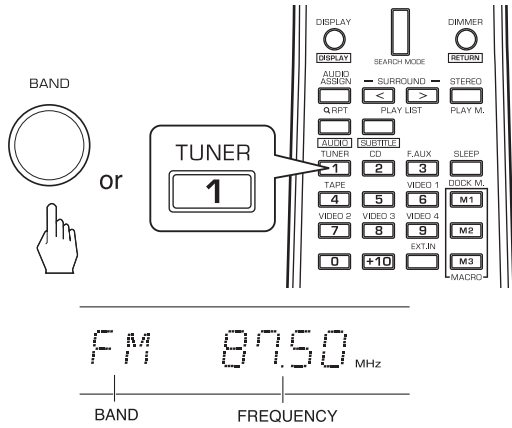

Each time this button is pressed, the band changes as follows :

→ FM ST → FM MONO → AM
 ("ST" lights up) ("ST" goes off)

When FM stereo broadcasts are poor because of weak broadcast signals, select the FM mono mode to reduce the noise, then FM broadcasts are reproduced in monaural sound.

2. Press the TUNING UP(+)/DOWN(-) buttons for more than 0.5 second.

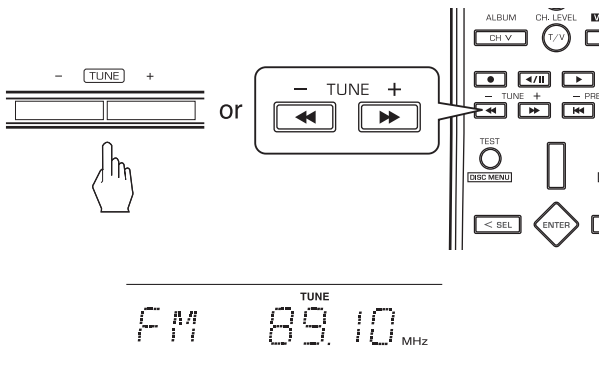

- The tuner will now search until a station of sufficient strength has been found. The display shows the tuned frequency and "TUNE".
- If the station found is not the desired one, simply repeat this operation.
- Weak stations are skipped during auto tuning.

Manual tuning

- Manual tuning is useful when you already know the frequency of the desired station.
- After selecting the desired band, press the TUNING UP(+)/DOWN(-) buttons repeatedly until the right frequency has been reached.

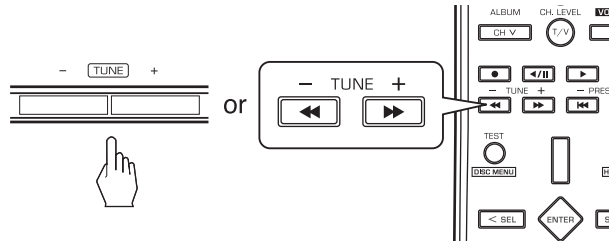

Auto presetting

- Auto presetting function automatically searches for FM stations only and store them in the memory.
- While listening to FM or AM radio broadcasts, press and hold down the (MEMORY)/ENTER button for more than 2 seconds.

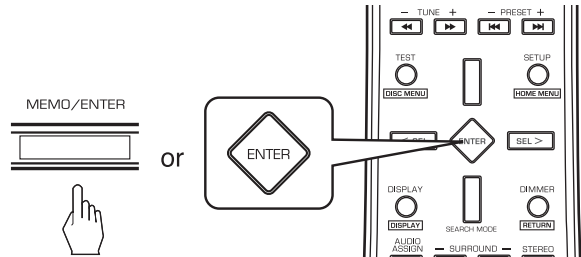

- Then "AUTO MEM" flickers and this receiver starts auto presetting.
- To stop auto presetting, press this button again.
- Up to 30 FM stations can be stored.

Notes:

- FM stations of weak strength cannot be memorized.
- To memorize AM stations or weak stations, perform "Manual presetting" procedure with using "Manual tuning" operation.

Manual presetting

- You can store up to 30 preferred stations in the memory.

- Tune in the desired station with auto or manual tuning.
- Press the (MEMORY)/ENTER button.

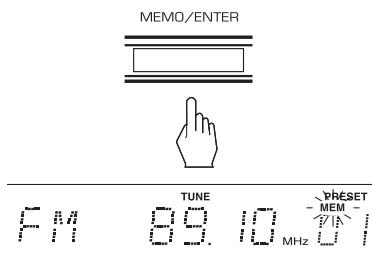

- "MEM" is flickering for several seconds.

- Select the desired preset number (1~30) and press the (MEMORY)/ENTER button.

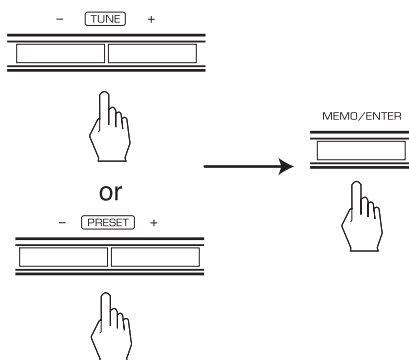

- The station has now been stored in the memory.
- A stored frequency is erased from the memory by storing another frequency in its place.
- If "MEM" goes off, start again from the above step 2.

- Repeat the above steps 1 to 3 to memorize other stations.

■ MEMORY BACKUP FUNCTION

The following items, set before the receiver is turned off, are memorized.

- INPUT SELECTOR settings
- Surround mode settings
- Preset stations, etc.

Tuning to preset stations

- After selecting the tuner as an input source, select the desired preset number.

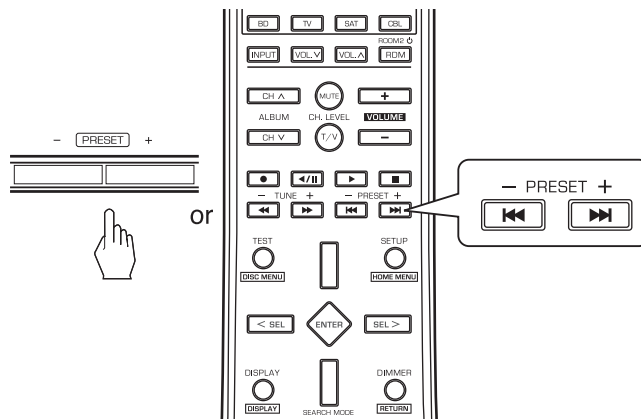

RDS Tuner(Regional Option for some countries in Europe, etc.)

LISTENING TO RDS BROADCASTS(FM ONLY)

RDS(Radio Data System) is a method for sending information signals together with the transmitter signals. Your tuner is capable of translating these signals and putting the information on the display. These codes contain the following information. Program Service name(PS), A list of Program Types(PHY), Traffic Announcement(TA), Clock Time(CT), Radio Text(RT).

Note :

- In the other countries, RDS tuner function cannot be available.

RDS search

- Use this function to automatically search and receive the stations offering RDS services.

1. In the FM mode, select the RDS search mode.

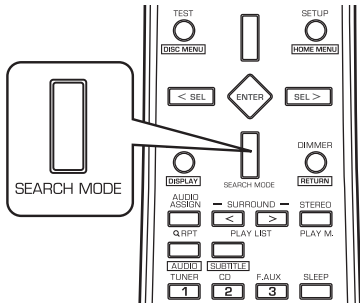

- Each time this button is pressed, the search mode changes as follows;

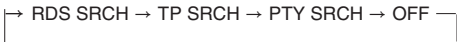

2. While displaying "RDS SRCH".

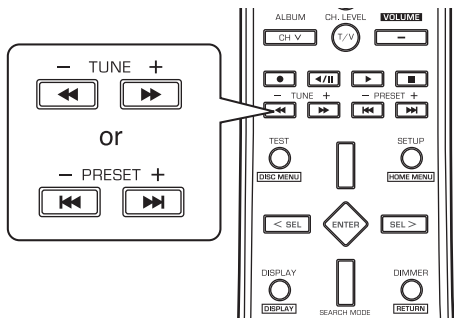

- The tuner automatically searches stations offering RDS services and the station name is displayed.
- If no other RDS station is found, "NO RDS" is displayed.
- When "RDS SRCH" is not displayed, repeat again from the above step 1.

TP search

- Use this function to automatically search and receive the stations broadcasting the traffic program.

1. In the FM mode, select the TP search mode.

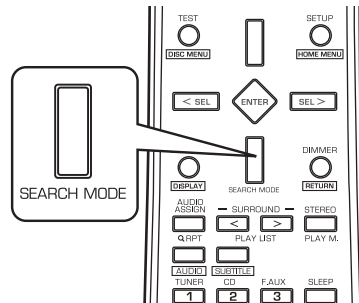

- "TP SRCH" is displayed.

2. While displaying "TP SRCH".

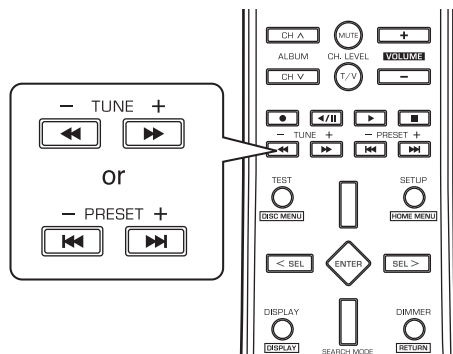

- The tuner automatically searches stations broadcasting the traffic program.
- "NO TRAFF" is displayed if the signal is too weak or there are no stations broadcasting the traffic program.
- When "TP SRCH" is not displayed, repeat again from the above step 1.

PTY search

- Use this function to automatically search and receive the stations broadcasting the desired program type.

1. In the FM mode, select the PTY search mode.

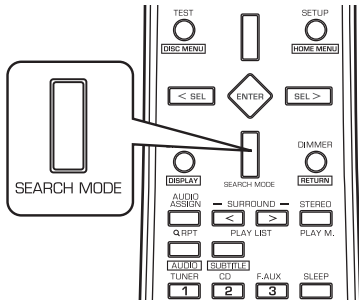

- "PTY SRCH" is displayed.

2. While displaying "PTY SRCH", select the desired program type.

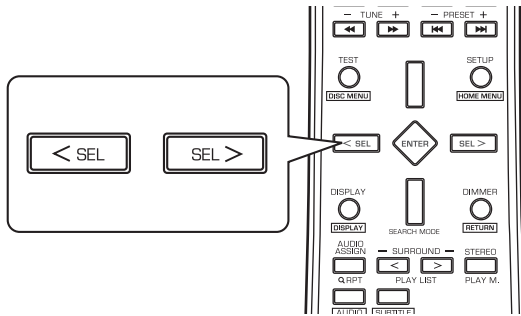

- Each time these buttons are pressed, one of 32 different types of programs is selected.
(NEWS, AFFAIRS, INFO, SPORT, EDUCATE, DRAMA, CULTURE, SCIENCE, VARIED, POP M, ROCK M, EASY M, LIGHT M, CLASSICS, OTHER M, WEATHER, FINANCE, CHILDREN, SOCIAL, RELIGION, PHONE IN, TRAVEL, LEISURE, JAZZ, COUNTRY, NATION M, OLDIES, FOLK M, DOCUMENT, TEST, ALARM, NONE)

- When "PTY SRCH" is not displayed, repeat again from the above step 1.

3. While displaying the desired program type.

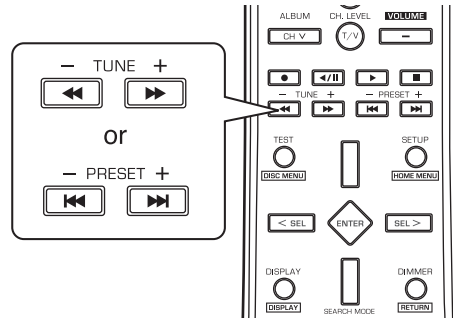

- The tuner automatically searches a station offering PTY services.
- If no station is found, "NO PROG" is displayed.

DISPLAY

- In the FM mode,

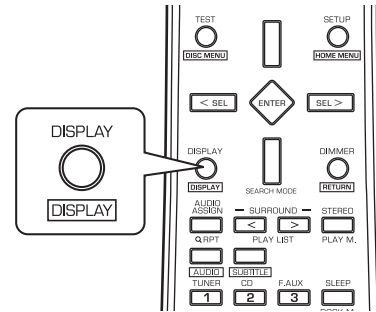

- Each time the DISPLAY button is pressed, the display mode changes as follows:

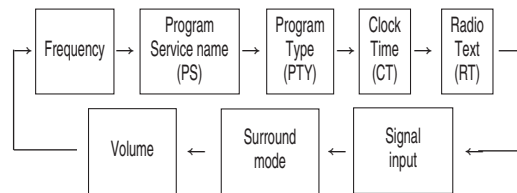

- If the signals are too weak or no RDS service is available, "NO NAME", "NO PTY", "NO TIME" or "NO TEXT" will be displayed.

RECORDING

- The analog signals from the EXTERNAL INs as well as the digital signals from the HDMI IN, the OPTICAL or the COAXIAL DIGITAL IN can be heard but cannot be recorded.
- When recording the analog signals from CD, F.AUX, VIDEO 2~4, be sure to select "Analog" for the Audio Mode. (For details, refer to "When selecting the Audio Mode" on page 53.)
- The volume and tone (bass, treble) settings have no effect on the recording signals.

Dubbing from video components onto VIDEO 1

1. Select the desired of VIDEO 2/(iPod) ~ 4 as a recording source except VIDEO 1.

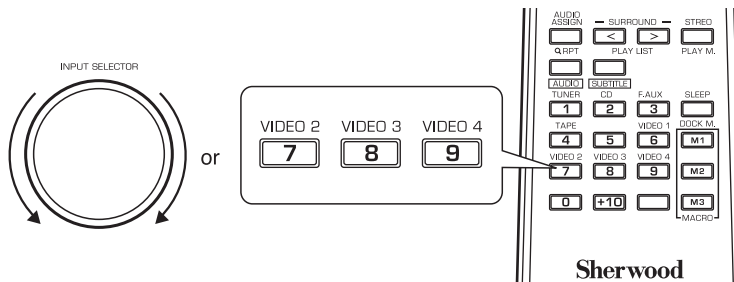

2. Start recording on the VIDEO 1.

3. Start play on the desired input.

- The audio and video signals from the desired input will be dubbed onto the VIDEO 1 and you can enjoy them on the TV set and from the speakers.

■ To record audio signals

- Connect the AUDIO IN/OUT jacks of "VIDEO 1" to audio recording equipment such as a tape deck, an MD recorder, etc. and select the desired of tuner, CD, F.AUX, TAPE and VIDEO 2/(iPod)~4 as a recording source. Then you can record the audio signals from the selected input.

DIGITAL AUDIO RECORDING WITH MD RECORDER

- Only when the OPTICAL DIGITAL OUT of this receiver is connected to the OPTICAL DIGITAL IN of the MD recorder or CD recorder, you can enjoy high-quality sound of digital recording without converting the original signals. Refer to "CONNECTING VIDEO COMPONENTS", "CONNECTING AUDIO COMPONENTS" and "CONNECTING DIGITAL INS AND OUT" on pages 5 ~7 and the operating instructions of the MD recorder or CD recorder.

Notes:

- The digital audio signals input into the OPTICAL and the COAXIAL DIGITAL INs (, not the HDMI INs) can be output from the OPTICAL DIGITAL OUT.
- Depending on the digital audio signal format, some digital signals cannot be output from the OPTICAL DIGITAL OUT.
- Digital recording is available for the digital audio program sources such as CDs, MDs, some DVDs, etc.
- There are some restrictions on recording digital signals. When making digital recordings, refer to the operating instructions of your digital recording equipment to know what restrictions are imposed.

1. Select the desired of CD, F.AUX, VIDEO 1~4, EXT.IN as a recording source.

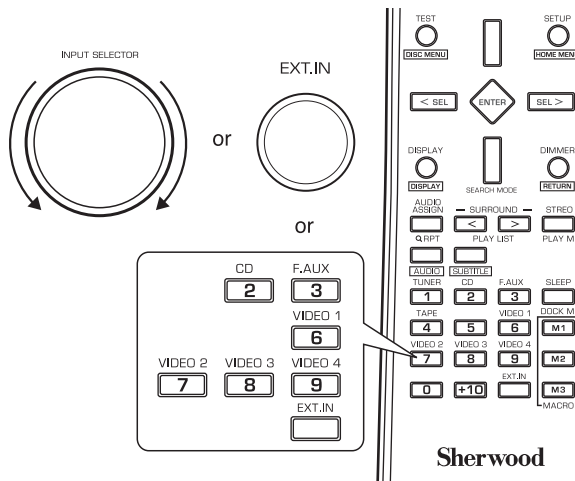

2. For digital recording, select the digital input as recording signal input.

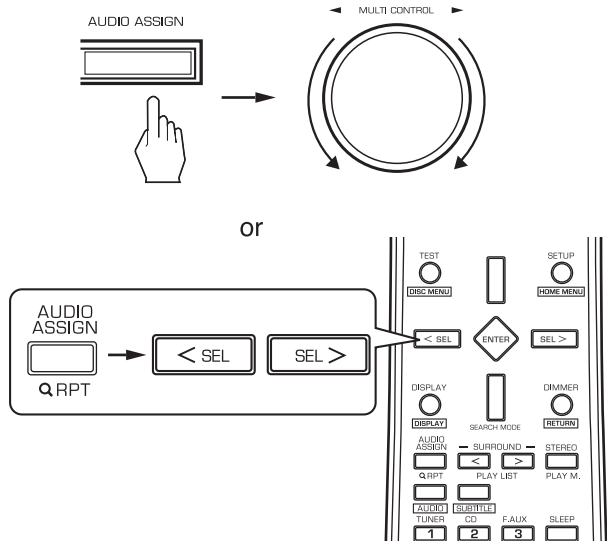

Note :

- If the Audio Mode is set to the mode other than "Digital" for the corresponding recording source on the INPUT SETUP menu, the digital audio signals from the selected digital input will not be output and there will be no recording. (For details, refer to "When CD, F.AUX, VIDEO 1~4, EXT.IN is selected as an input source" on page 20 and "When selecting the Audio Mode" on page 53.)

3. Start recording on the component connected to the OPTICAL DIGITAL OUT.

4. Start play on the desired input.

OTHER FUNCTIONS

Operating the sleep timer

- The sleep timer allows the system to continue to operate for a specified period of time before automatically shutting off.
- To set the receiver to automatically turn off after the specified period of time.

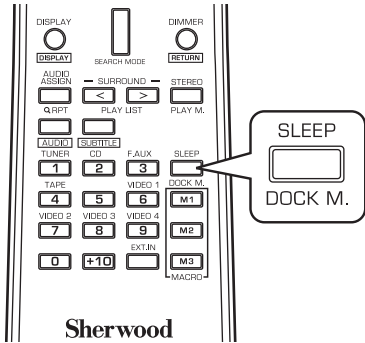

- Each time this button is pressed, the sleep time changes as follows:

→ 10 → 20 → 30 → --- → 90 → OFF
Unit : minutes

- While operating the sleep timer, "☾" lights up.
- When the sleep time is selected, the fluorescent display is dimly lit.

Adjusting the brightness of the fluorescent display

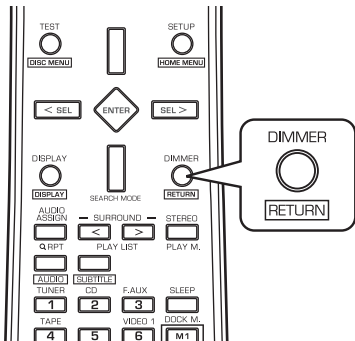

- Each time this button is pressed, the brightness of the fluorescent display changes as follows:

→ ON → dimmer → OFF

- In the display OFF mode, pressing any button will restore the display ON mode.

Displaying the operation status

During playback,

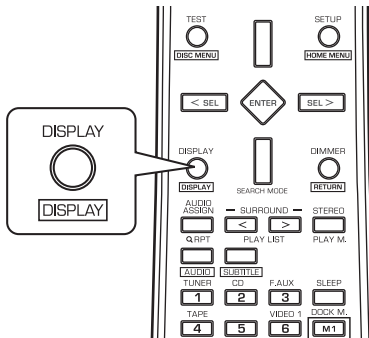

- Each time this button is pressed, the display mode changes as follows:

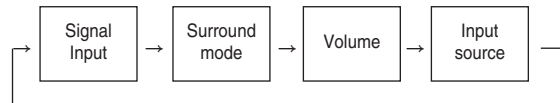

- When RDS tuner function is available in your country, for details on the FM mode information, see "DISPLAY" on page 30.

ROOM 2 SOURCE PLAYBACK

- This function allows enjoying one source in the main room and playing another in a different room at the same time.

■Notes:

- The analog signals from the EXTERNAL INs and the digital signals cannot be output to the different room, meaning no playback in a different room.
- Only the (composite) video signals can be output to the different room.
- When the EXTERNAL IN is selected as a main input, if the MAIN source is selected as a ROOM 2 input, no audio signal can be heard in the different room (ROOM 2).
- Even when this receiver enters the standby mode, in such a case that only the "R2" lights up still, meaning only the ROOM 2 circuitry operates, the ROOM 2 source can be played independently.
- When you do not use the ROOM 2 function, turn off the ROOM 2 function to save electricity.

When using the buttons on the front panel

1. Press the ROOM 2 button to enter the ROOM 2 mode.

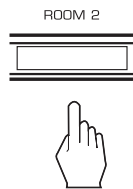

- ROOM 2 ~ is displayed for several seconds.
- When the ROOM 2 setting mode disappears, press the ROOM 2 button again.

2. Select the desired mode while displaying the ROOM 2 setting mode.

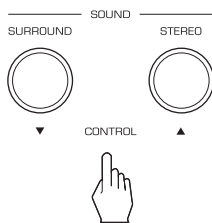

- Each time these buttons are pressed, the mode changes as follows :
 - ROOM 2 ~ : To turn on or off the ROOM 2 function. (ROOM 2 mode)
 - ↓
 - IN ~ : To select the desired ROOM 2 source. (ROOM 2 input)
 - ↓
 - VOL ~ : To adjust the volume on the power (ROOM 2 volume) amplifier assigned to "Surr Back↔ Room 2" or "Room 2".

■Note :

- When the ROOM 2 mode is set to OFF, the ROOM 2 input and the ROOM 2 volume cannot be selected.

3. Set the selected mode as desired.

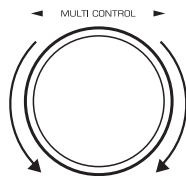

■When selecting the ROOM 2 mode.

- ON : To turn on the ROOM 2 function.
- ↓ ("R2" lights up.)
- OFF : To turn it off. ("R2" goes off.)

■When selecting the ROOM 2 input.

- You can select the desired among MAIN source, TUNER, CD, F.AUX, TAPE, VIDEO 1 ~ VIDEO 4 as a ROOM 2 source.

■When selecting the ROOM 2 volume.

- You can adjust the volume on the power amplifier assigned to "Surr Back↔Room 2" or "Room 2" when the ROOM 2 speaker terminals are connected to the speakers in a different room. (For details, refer to "When selecting the AMP Assign" on page 41.)

4. Start play on the component related to the ROOM 2 source.

When using the buttons on the remote control unit

1. Turn on the ROOM 2 function.



- ROOM 2 ~ is displayed for several seconds.
- Each time the button is pressed, the ROOM 2 mode changes as follows :
ON : To turn on the ROOM 2 function.
↑ ("R2" lights up.)
OFF : To turn it off. ("R2" goes off)

■ **Note :**

- When ROOM 2 mode is set to OFF, the ROOM 2 volume cannot be selected.

2. Select the desired input as a ROOM 2 source.



- Each time the "INPUT" button is pressed, the ROOM 2 input can be selected among MAIN source, TUNER, CD, F.AUX, TAPE, VIDEO 1 ~ VIDEO 4 as a ROOM 2 source.

3. Adjust the ROOM 2 volume.



- You can adjust the volume on the power amplifier assigned to "Surr Back↔Room 2" or "Room 2". (For details, refer to "When selecting the AMP ASSIGN" on page 41.)

4. Start play on the component related to the ROOM 2 source.

OSD Menu Settings

- The OSD (On-Screen Display) menu is a setting menu that is displayed on the monitor TV and allows you to perform the setup procedures easily. In most situations, you will only need to set this once during the installation and layout of your home theater, and it rarely needs to be changed later.

The OSD menu consists of 6 main menus ; system setup, speaker/room EQ setup, input setup, multi room setup, sound parameter and advanced video . These menus are then divided up into various sub-menus.

Notes:

- The OSD menu and the momentary OSD can be displayed via the HDMI MONITOR OUT only.
However, when the Video Scaling is set to HDMI Bypass and the video signals are input into the HDMI IN, the momentary OSD cannot be displayed via the HDMI MONITOR OUT. (For details, refer to “When selecting the Video Scaling” on page 53.)
- When performing the OSD menu operation, the corresponding operation status is displayed on the unit’s fluorescent display, too. Therefore, in such a case that the OSD menu cannot be displayed on your TV, perform the setup procedure, viewing the corresponding operation status on the fluorescent display. (For details on setup menu, refer to “Setup menu flow” on page 38.)

Navigating through the OSD menu

- The explanations here assume you are using the buttons on the remote control when performing the OSD menu operation. However, you can use the buttons on the front panel as well.

The buttons on the front panel correspond to those on the remote control as shown below.

Button on the remote control				
Button on the front panel				

1. Turn the menu screen on.

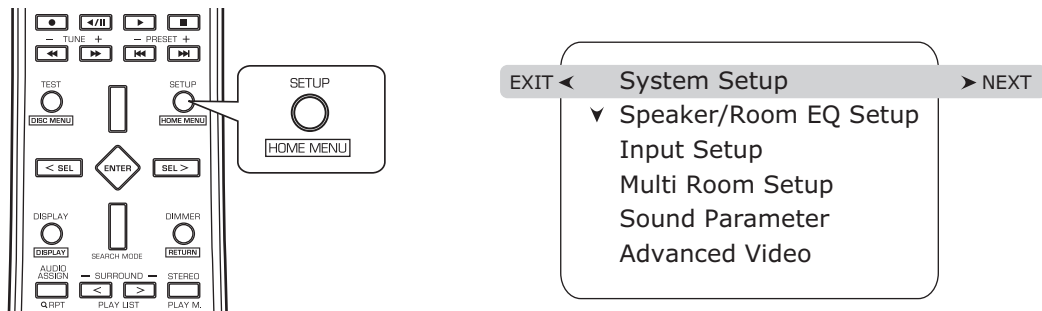

- The main menu will be shown.
- To turn the menu screen off, press this button again.

2. Select the desired menu using the CURSOR UP/DOWN buttons.

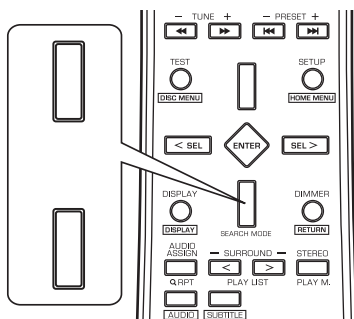

3. Enter the selected menu using the CURSOR RIGHT button.

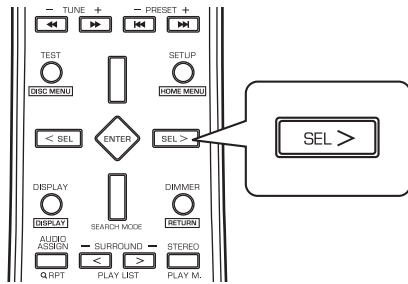

- When the CURSOR LEFT button is pressed on a sub-menu, etc. the previous menu will be returned.

ENGLISH

■ When selecting the System Setup

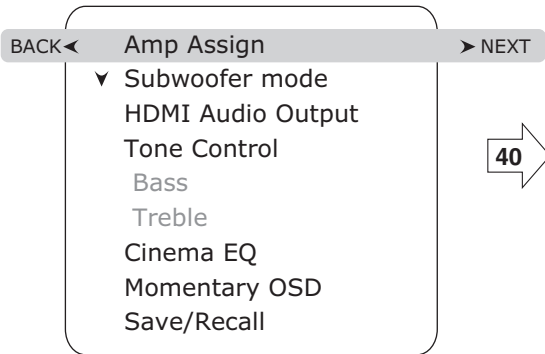

■ When selecting the Speaker/Room EQ Setup

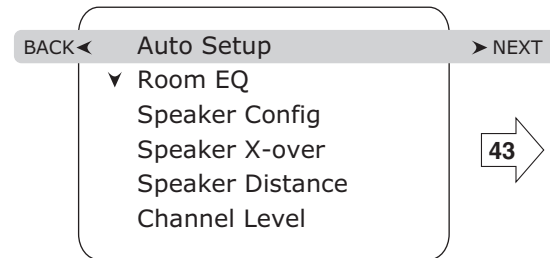

■ When selecting the Input Setup

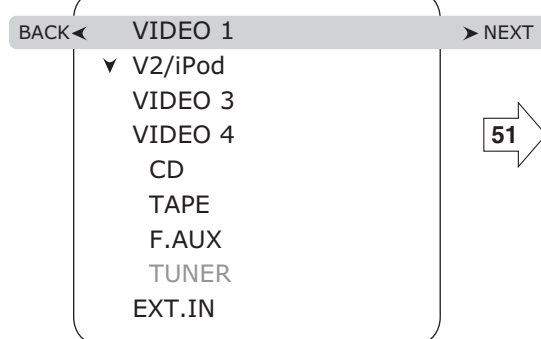

■ When selecting the Multi Room Setup

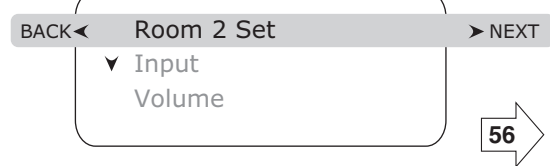

■ When selecting the Sound Parameter

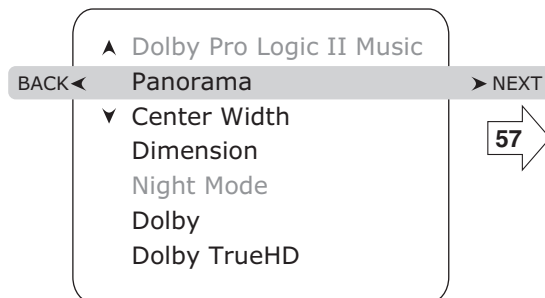

■ When selecting the Advanced Video

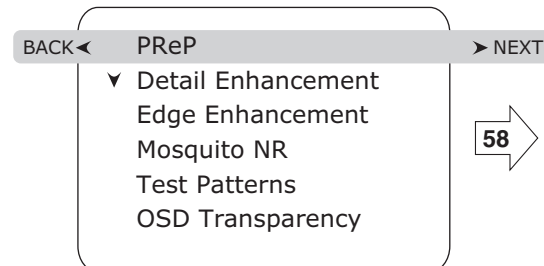

- For the setting details, see page in .
- Adjust the setting(s) in each setting category to your preference.
- When the SETUP button is pressed on a sub-menu, the menu screen will be turned off.

Setup menu flow

ENGLISH

■ : Default settings

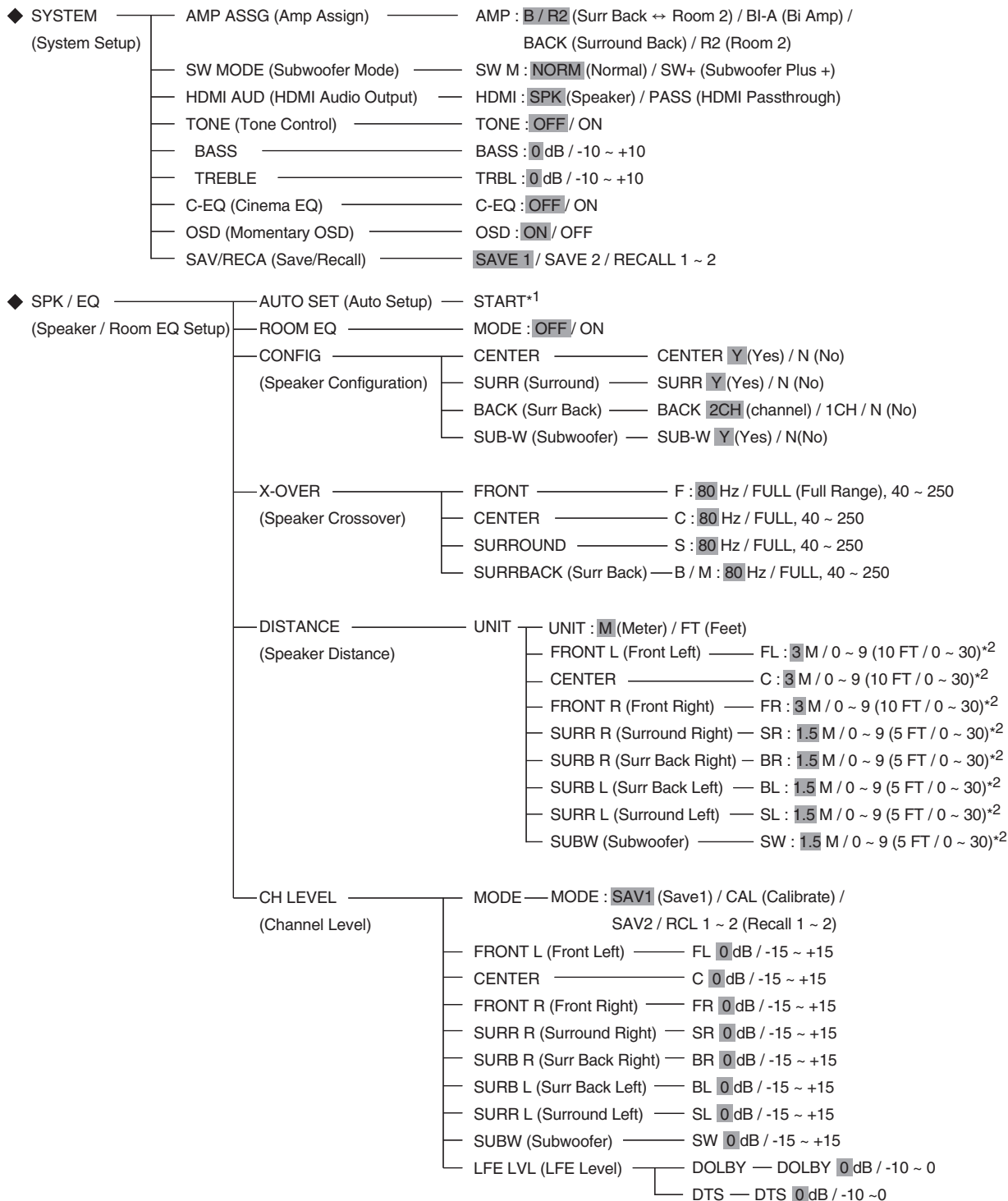

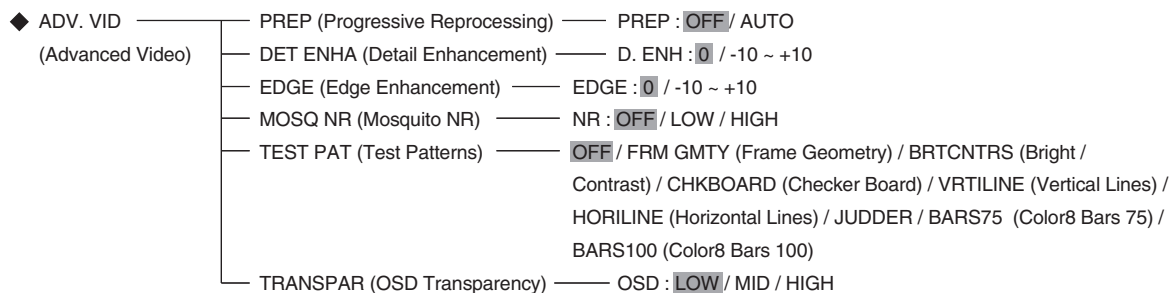
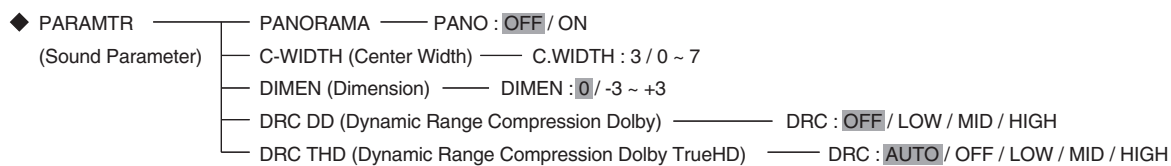
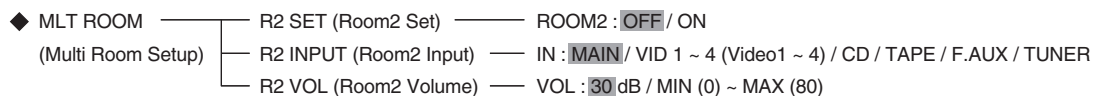
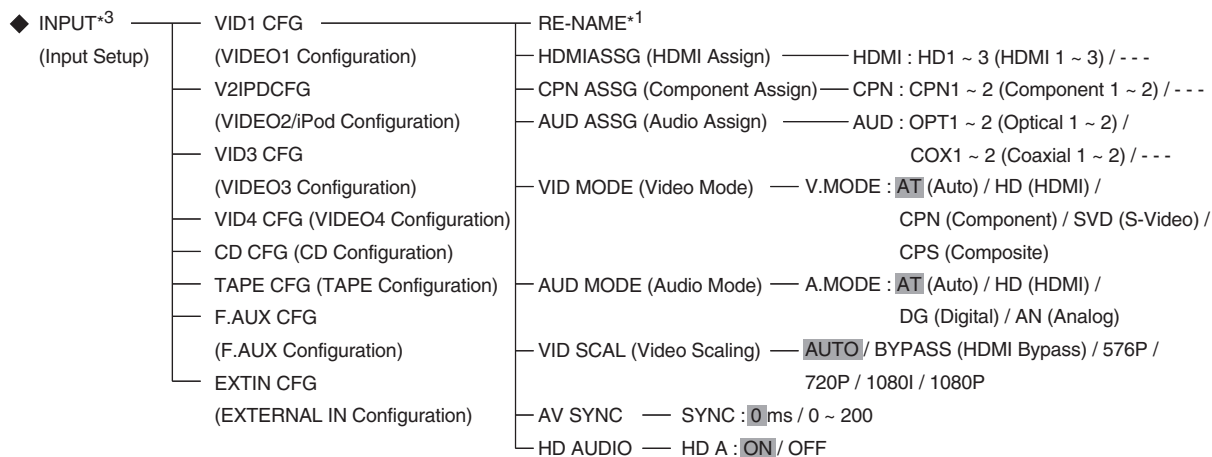

*1 : For the setting details, refer to the corresponding operating instructions on the OSD Menu Settings.

*2 : These are the setting values when the UNIT is set to FT (Feet).

*3 : Depending on the input source, some items cannot be selected.

ENGLISH

SETTING THE SYSTEM SETUP

BACK < Amp Assign > NEXT

- ▼ Subwoofer mode
- HDMI Audio Output
- Tone Control
 - Bass
 - Treble
- Cinema EQ
- Momentary OSD
- Save/Recall

- AMP Assign : To assign the surround back channels' power amplifier correctly depending on how to use the speakers.
- Subwoofer Mode : To select the desired subwoofer mode.
- HDMI Audio Output : To output the digital audio signals from the HDMI MONITOR OUT connector.
- Tone Control : To adjust the tone (bass and treble) as desired.
- Cinema EQ : To select the desired cinema EQ mode.
- Momentary OSD : To turn on or off the OSD that shows the status corresponding to each operation momentarily.
- Save/Recall : To memorize all the OSD menu setting values into memory or to recall the memorized setting values.

1. Press the CURSOR UP/DOWN buttons to select the desired item, then press the CURSOR RIGHT button to enter its setting menu.

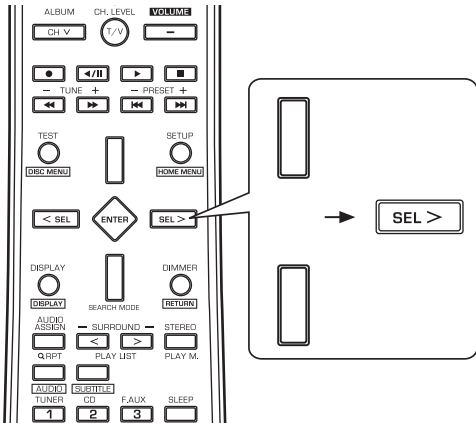

2. Press the CURSOR UP/DOWN buttons to set the selected item as desired, then press the ENTER button.

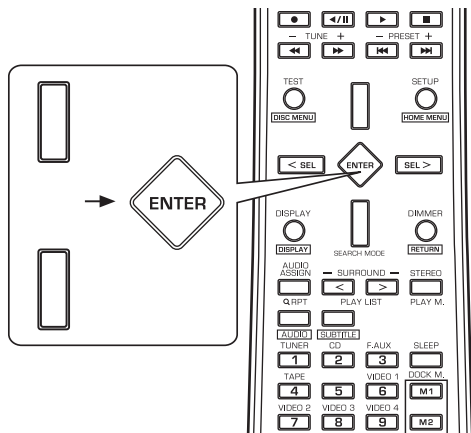

- Then the setting value is marked with “(OK)”.
- When the CURSOR LEFT(◀) button is pressed on a setting menu, the previous menu will be returned to.

Continued

When selecting the AMP Assign

- The surround back channels' power amplifier can drive the surround back speakers, the ROOM 2 speakers or the front bi-amp capable speakers. Depending on how to use the speakers, you should assign the power amplifier correctly. (For details, refer to "CONNECTING SPEAKERS" on page 8 and "CONNECTING ROOM 2 OUTS" on page 10.)

Surr Back ↔ Room 2 : When connecting this receiver to the surround back speakers and the ROOM 2 speakers both, the power amplifier automatically drives the surround back speakers or the ROOM 2 speakers depending on whether the ROOM 2 function is turned off or on.

Bi AMP : To drive the front bi-amp capable speakers when connecting the FRONT and the SURROUND BACK/MULTI channels to them.

Surround Back : To drive the surround back speakers when connecting the SURROUND BACK/MULTI channels to them.

Room 2 : To drive the ROOM 2 speakers when connecting the ROOM 2 channels to them.

When selecting the Subwoofer Mode

- "Subwoofer Plus+" mode is valid only when "Front" and "Center" are set to "Full Range" and "Subwoofer" is set to "Yes" on the Speaker/Room EQ Setup menu. (For details, refer to "SETTING THE SPEAKER/ ROOM EQ SETUP" on page 43.)

Normal : When the low frequency signals of channels set to "Full Range" are reproduced from those channels only. In this mode, the low frequency signals that are reproduced from the subwoofer channel is only the low frequency signals of LFE (from the multi-channel sources that contains LFE (Low Frequency Effects) channel, also called the ".1" channel) and the channels set to the setting value other than "Full Range".

Subwoofer Plus+ : When the low frequency signals of channels set to "Full Range" are reproduced simultaneously from those channels and the subwoofer channel.
In this mode, the low frequency range expands more uniformly through the room, but depending on the size and shape of the room, interference may result in a decrease of the actual volume of the low frequency range.

When selecting the HDMI Audio Output

- The HDMI connection can carry uncompressed digital video signals and digital audio signals. Depending on whether the digital audio signals input into the HDMI IN are output from the HDMI MONITOR OUT of this receiver or not, you should set the HDMI Audio Output correctly.
Speaker : Not to output the HDMI digital audio signals from the HDMI MONITOR OUT of this receiver, meaning these signals are heard from the speakers connected to this receiver.
HDMI Passthrough : To output the HDMI digital audio signals from the HDMI MONITOR OUT, meaning these signals are heard from the speakers of your TV.

■Note:

- When the HDMI Audio Output is set to HDMI Passthrough, no sound will be heard from the speakers connected to this receiver (except ROOM 2 speakers) even though any input source is selected.

When selecting the Tone Control

On : To adjust the tone for your taste. ("DIR" goes off.)

↓

Off : To listen to a program source without the tone effect. ("DIR" lights up.)

■When adjusting the tone (Bass and Treble)

- You can adjust the tone only when the Tone Control is set to On.
 - ① Press the CURSOR UP/DOWN buttons to select the desired tone, then press the CURSOR RIGHT button to enter its setting menu.
 - ② Press the CURSOR UP/DOWN buttons to adjust the selected tone as desired.
 - The tone level can be adjusted within the range of -10 ~ +10 dB.
 - In general, we recommend the bass and treble to be adjusted to 0 dB (flat level).
 - Extreme settings at high volume may damage your speakers.

Continued

When selecting the Cinema EQ

On : To compensate for edgy or shrill movie sound tracks.

↓

Off : To turn off the cinema EQ function.

When selecting the Momentary OSD

On : To turn on the OSD function that shows the status corresponding to each operation on this unit momentarily.

↓

Off : To turn it off.

■Note :

- The OSD menu and the momentary OSD can be displayed via the HDMI MONITOR OUT only. However, when the Video Scaling is set to the HDMI Bypass, they cannot be displayed via the HDMI MONITOR OUT. (For details, refer to “When selecting the Video Scaling” on page 53.)

When selecting the Save/Recall

- You can memorize all the OSD menu setting values into memory 1(“Save 1”) or memory 2(“Save 2”) and recall the memorized setting values whenever you want.

Save 1 : To memorize all the OSD menu setting values into memory 1.

↓

Save 2 : To memorize them into memory 2.

↓

Recall 1 : To recall the setting values memorized into memory 1.

↓

Recall 2 : To recall the setting values memorized into memory 2.

SETTING THE SPEAKER / ROOM EQ SETUP

- After you have installed this receiver and connected all the components, you should adjust the speaker settings for the optimum sound acoustics according to your environment and speaker layout.
- Even when you change speakers, speaker positions, or the layout of your listening environment, you should adjust the speaker settings, too.
- When performing the Auto Setup procedure, you need not perform the Speaker Configuration, Speaker Crossover, Speaker Distance and Channel Level setup procedures.

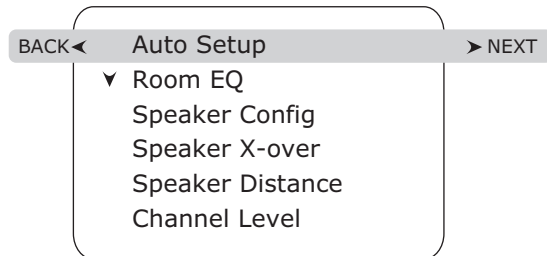

- Auto Setup : To set the speaker setup and channel level setup automatically.
- Room EQ : To select the desired room EQ mode.
- Speaker Configuration : To adjust the speakers depending on whether they are connected or not.
- Speaker Crossover : To select the desired crossover frequency.
- Speaker Distance : To select the distance between the listening position and each speaker to set the delay time automatically for optimum surround playback.
- Channel Level : To adjust the channel levels as desired or to memorize them into the preset memory.

When selecting the Auto Setup

- Auto Setup lets you avoid troublesome listening-based speaker setup and achieve good surround sound. Auto Setup has the feature that provides the optimum listening environment at the listening position in your room. You should connect the supplied microphone to the SETUP MIC jack so that this receiver can analyze the information from a series of test tones emitted from speakers at main listening position and can adjust the configuration, distance, sound level, crossover frequency and frequency response of each speaker automatically.
- If you want to personalize your speaker setup and channel level setup by making the settings manually, perform the "When selecting the Speaker Configuration" on page 46, "When selecting the Speaker Crossover" on page 47, "When selecting the Speaker Distance" on page 48 and "When Selecting the Channel Level" on page 49.
- After the auto setup has been completed, set the room EQ as desired. (For details, refer to "When selecting the Room EQ" on page 45.)

■ Preparations

- ① Check that the speakers are securely connected to this receiver.
 - If your subwoofer has adjustable volume and crossover frequency, set the volume halfway and set the crossover frequency to the maximum or the low pass filter off.
- ② Connect the supplied microphone to the SETUP MIC jack on the front panel. (For details, refer to "SETUP MIC JACK" on page 12.)

■ Notes :

- Because the microphone for Auto Setup is designed for use with this receiver, to use the auto setup function, do not use a microphone other than the one supplied with this receiver.
- After you have completed the auto setup procedure, disconnect the microphone.

1. Place the microphone on a flat level surface at the listening position.

- If possible, use a tripod, etc. to attach the microphone at the same height as your ears would be when you are seated in your listening position.
- Ensure there are no obstacles between the speakers and the microphone.

Continued

2. Press the CURSOR UP/DOWN buttons to select the Auto Setup, then press the CURSOR RIGHT button.

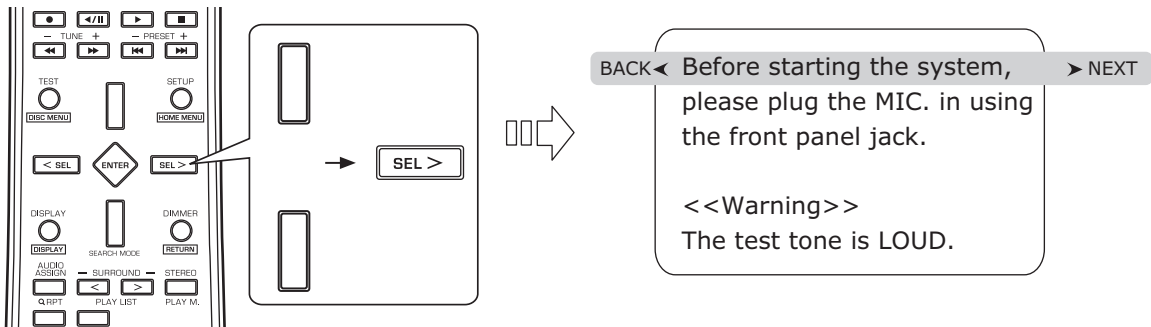

3. Press the CURSOR RIGHT button to start the auto setup procedure.

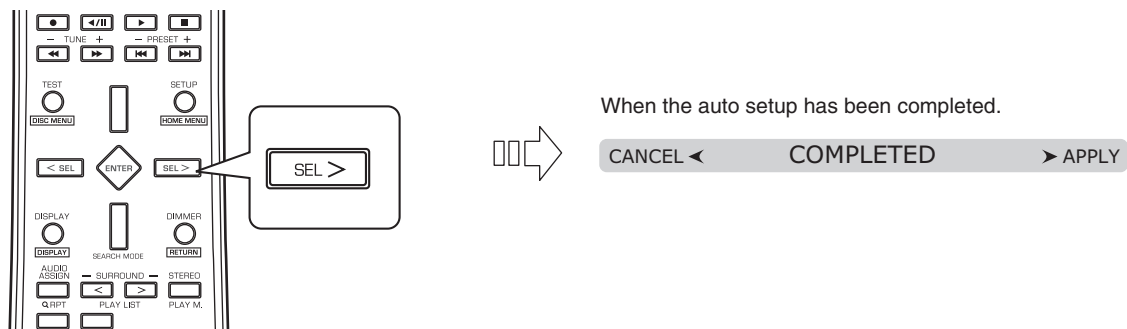

- Loud test tones are output successively and then if a series of auto setup procedure has been completed, "COMPLETED" will be displayed.
- To stop the auto setup procedure while performing it, press the CURSOR LEFT button. In such a case that the auto setup procedure is stopped before "COMPLETED" is displayed, the results of each adjustment can not be memorized.
- If there may be a problem with speaker or microphone connection, error message will be displayed. In this case, turn off the power, check the connection and then retry the auto setup procedure.

■ Notes :

- Because the test tones are loud, ensure there no infants or small children in the room.
- For best results, ensure the room is as quiet as possible during the auto setup procedure. If there is too much ambient noise, the results may not be satisfactory.

4. To memorize the results, press the CURSOR RIGHT button.

- Then the results are memorized and the Speaker/Room EQ Setup menu is displayed.
- When the CURSOR LEFT button is pressed to select "CANCEL", the results are not memorized.
- Check the results on each setup menu(Speaker Configuration menu on page 46, Speaker Crossover menu on page 47, Speaker Distance menu on page 48 and Channel Level menu for "Calibrate" mode) on page 49).
- If the results are not satisfactory, you can retry the auto setup procedure or personalize your speaker setup and channel level setup by making the settings manually. (For details, refer to "When selecting the Speaker Configuration" on page 46, "When selecting the Speaker Crossover" on page 47, "When selecting the Speaker Distance" on page 48 and "When selecting the Channel Level" on page 49.)

When selecting the Room EQ

- The room EQ is a kind of room equalizer for your speakers. According to the acoustic characteristics of your room measured by the auto setup, the room EQ automatically adjusts the frequency response of your speakers.
- If you use different brands or sizes of speakers for some channels or have a room with unique acoustic characteristics, such as walls, furniture, and the dimensions or the shape of the room, we recommend using the room EQ.

■Note :

- To use the room EQ, first you should finish measuring the acoustic characteristics of your room performing the auto setup. (For details, refer to "When selecting the Auto Setup" on page 43.)

1. Press the CURSOR UP/DOWN buttons to select the Room EQ, then press the CURSOR RIGHT button to enter the setting menu.

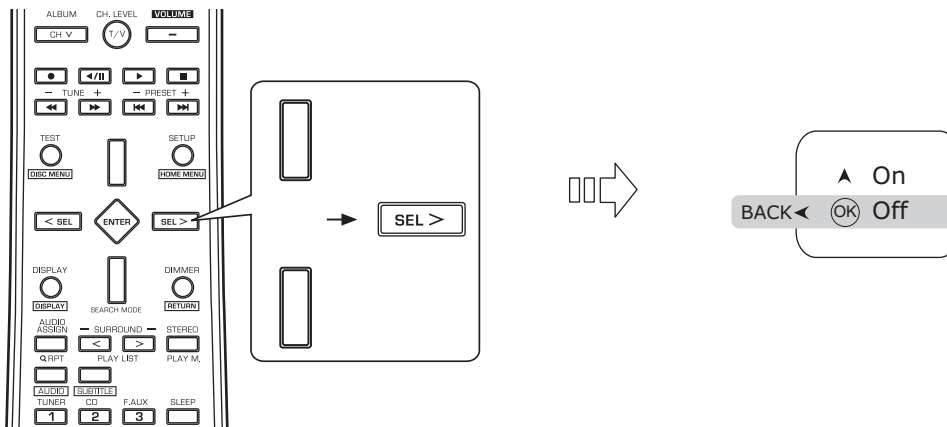

2. Press the CURSOR UP/DOWN buttons to select the desired room EQ mode, then press the ENTER button.

On : To adjust the frequency response of all speakers to the flattest response.



Off : To turn off the room EQ.

- When the CURSOR LEFT button is pressed on the setting menu, the previous menu will be returned to.

When selecting the Speaker Configuration

1. Press the CURSOR UP/DOWN buttons to select the Speaker Configuration, then press the CURSOR RIGHT button to enter the setting menu.

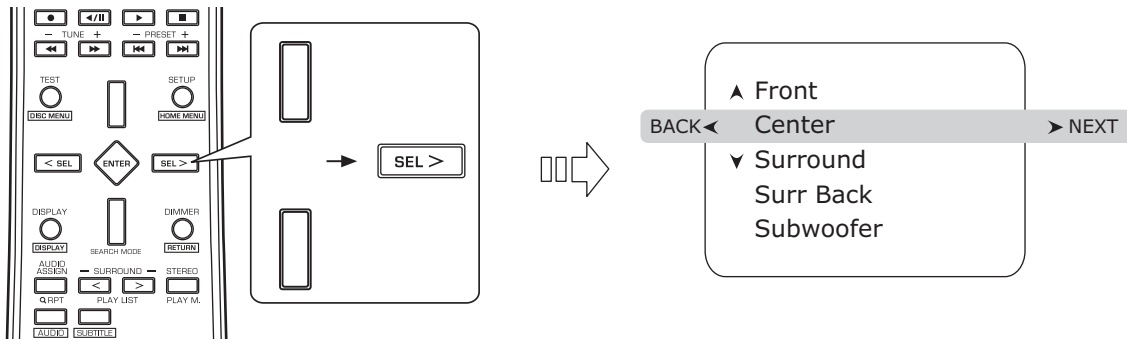

2. Press the CURSOR UP/DOWN buttons to select the desired speaker, then press the CURSOR RIGHT button to enter its setting menu.

3. Press the CURSOR UP/DOWN buttons to set the selected speaker as desired, then press the ENTER button.

Yes/No: Select the desired depending on whether the speakers are connected or not.

2 Channel/1 Channel (Left) : Select the desired depending on the number of speakers connected to SURROUND BACK/MULTI channels.

- When the CURSOR LEFT button is pressed on the setting menu, the previous menu will be returned to.

■ Notes :

- When speakers are not set to "No", you should set their distances from listening position and crossover frequencies according to their frequency characteristics. (For details, refer to "When selecting the Speaker Crossover" on page 47 and "When selecting the Speaker Distance" on page 48.)
- When the "Surround" is set to "No", "Surr back" cannot be set to "2 Channel" or "1 Channel(Left)".
- When the surround back channels' power amplifier is assigned to "Bi AMP" or "Room 2", the "Surr Back" cannot be selected. (For details, refer to "When selecting the AMP Assign" on page 41.)

4. Repeat the above steps 2 and 3 until the speakers are all set as desired.

When selecting the Speaker Crossover

- Set the crossover frequency according to the frequency characteristics of the speakers connected.
(For details on the frequency characteristics, refer to the operating instructions of the speakers.)
- If the frequency range of your speaker is 100 Hz ~ 20 kHz, the crossover frequency should be set to 100 Hz (or slightly higher).
- The low frequencies below the crossover frequency are to output from subwoofer or the speakers which are set to "Full Range" (when not using a subwoofer).

1. Press the CURSOR UP/DOWN buttons to select the Speaker X-over, then press the CURSOR RIGHT button to enter the setting menu.

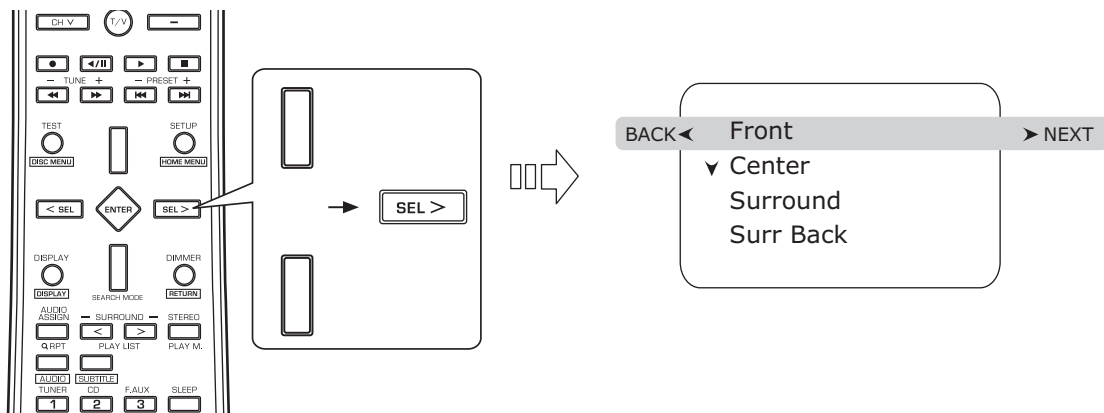

2. Press the CURSOR UP/DOWN buttons to select the desired speaker, then press the CURSOR RIGHT button to enter its setting menu.

■ **Note :**

- You cannot select the subwoofer and the speakers set to "No".

3. Press the CURSOR UP/DOWN buttons to set the crossover frequency as desired, then press the ENTER button.

- You can adjust the crossover frequency within the range of 40 ~ 250 Hz.
- Select "Full Range" when the selected speaker can fully reproduce the low frequencies below 40 Hz.
- When the CURSOR LEFT button is pressed on the setting menu, the previous menu will be returned to.

4. Repeat the above steps 2 and 3 until the crossover frequencies are all set as desired.

When selecting the Speaker Distance

1. Press the CURSOR UP/DOWN buttons to select the Speaker Distance, then press the CURSOR RIGHT button to enter the setting menu.

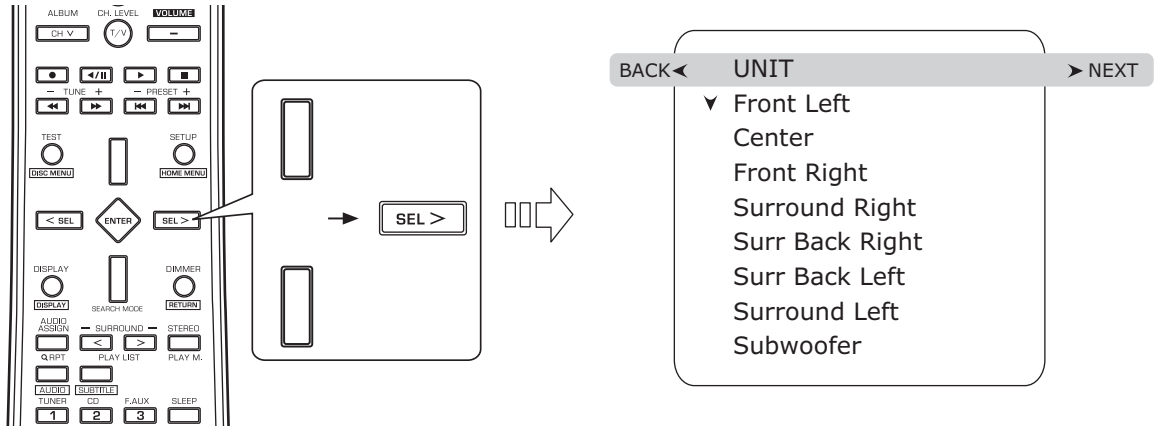

2. Press the CURSOR UP/DOWN buttons to select the desired item, then press the CURSOR RIGHT button to enter its setting menu.

■ Note :

- You cannot select the speakers set to "No".

3. Press the CURSOR UP/DOWN buttons to set the selected item as desired, then press the ENTER button.

■ When selecting the desired unit

- You can select either Meter or Feet.
- Once a unit is selected, the distances are automatically changed in the selected unit.

■ When setting the distance

- You can set the distance within the range of 0 ~ 9.0 meters in 0.1 meter intervals (or 0 ~ 30 feet in 0.5 feet intervals).
- When setting the distance, use the CURSOR UP/DOWN buttons only.
- When the CURSOR LEFT button is pressed on the setting menu, the previous menu will be returned to.

4. Repeat the above steps 2 and 3 until the distances are all set as desired.

■ About the speaker distance

When enjoying multi-channel surround playback with Dolby Digital and DTS sources, etc., it is ideal that the center, surround and surround back speakers etc. should be the same distance from the main listening position as the front speakers. By entering the distance between the listening position and each speaker, the delay times of center, surround and surround back speakers, etc. are automatically adjusted to create an ideal listening environment virtually as if the center, surround and surround back speakers, etc. were at their ideal locations respectively.

When selecting the Channel Level

- You can adjust the current channel levels as desired. These adjusted levels are just memorized into user's memory ("Calibrate"), not into preset memory("Save 1(Movie)", "Save 2(Music)").
- After adjusting each channel level with test tone, adjust the channel levels either according to the program sources or to suit your tastes.(For details, refer to "Adjusting each channel level with test tone" on page 24.)

1. Press the CURSOR UP/DOWN buttons to select the Channel Level, then press the CURSOR RIGHT button to enter the setting menu.

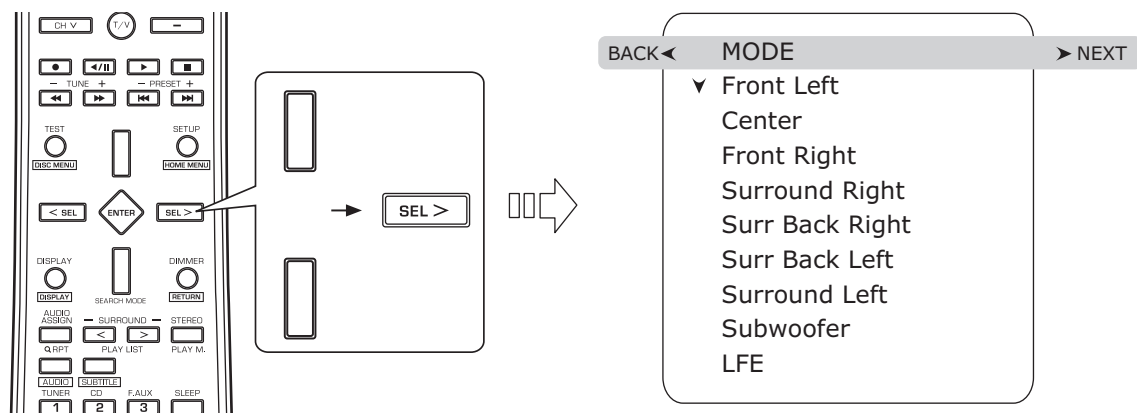

2. Press the CURSOR UP/DOWN buttons to select the desired channel(, not "MODE"), then press the CURSOR RIGHT button to enter its setting menu.

■When selecting the LFE

- Press the CURSOR UP/DOWN buttons to select the desired program source's LFE, then press the CURSOR RIGHT button to enter its setting menu.

■Note :

- Depending on the speaker settings("No", etc.), some channels cannot be selected.

3. Press the CURSOR UP/DOWN buttons to adjust the level of the selected channel or program source's LFE as desired.

- The LFE level can be adjusted within the range of -10 ~ 0 dB and other channel levels within the range of -15 ~ +15 dB
- In general, we recommend the LFE level to be adjusted to 0 dB.(However, the recommended LFE level for some early DTS software is -10 dB.) If the recommended levels seem too high, lower setting as necessary.
- When the CURSOR LEFT button is pressed on the setting menu, the previous menu will be returned to.

4. Repeat the above steps 2 and 3 to adjust each channel level.

Continued

■ Memorizing the adjusted channel levels and recalling them.

- You can memorize the adjusted channel levels into preset memory(“Save 1(Movie)”, “Save 2(Music)”) and recall the memorized whenever you want.

ENGLISH

1. Press the CURSOR UP/DOWN buttons to select the MODE on the Channel Level menu, then press the CURSOR RIGHT button to enter the setting menu.
-

2. Press the CURSOR UP/DOWN buttons to select the desired mode, then press the ENTER button.
-

Calibrate : To memorize the adjusted channel levels into user's memory.



Save 1(Movie) : To memorize the adjusted channel levels into memory 1.



Save 2(Music) : To memorize them into memory 2.



Recall 1(Movie) : To recall the channel levels memorized into memory 1.



Recall 2(Music) : To recall the channel levels memorized into memory 2.

SETTING THE INPUT SETUP

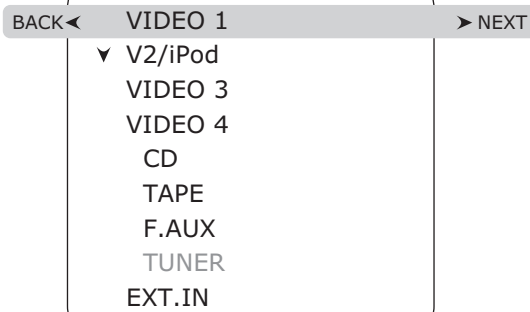

- This menu allows you to make the various settings depending on how to use the input sources connected to this receiver.

ENGLISH

When selecting the items other than Re-Name

1. Press the CURSOR UP/DOWN buttons to select the desired input source, then press the CURSOR RIGHT button to enter the setting menu.

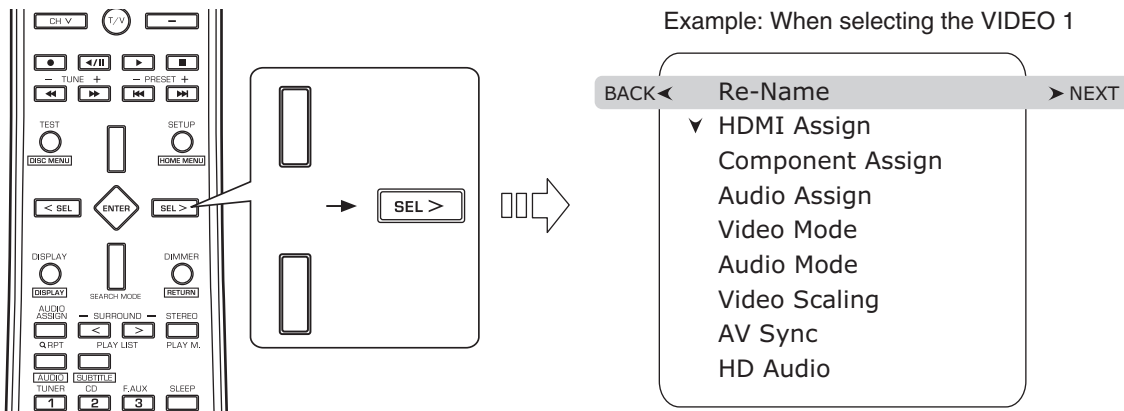

2. Press the CURSOR UP/DOWN buttons to select the desired item, then press the CURSOR RIGHT button to enter its setting menu.

■ **Note :**

- Depending on the input source, some items cannot be selected.

3. Press the CURSOR UP/DOWN buttons to set the selected item as desired, then press the ENTER button.

- When the CURSOR LEFT button is pressed on the setting menu, the previous menu will be returned to.
- When adjusting the AV Sync, use the CURSOR UP/DOWN buttons only.

Continued**■ When selecting the HDMI Assign**

- You should assign the connected HDMI INs to the desired of VIDEO 1 ~ VIDEO 4, EXT.IN.
(For details, refer to "CONNECTING VIDEO COMPONENTS" on pages 5 ~ 6.)
- You can select the desired of HDMI 1 ~ HDMI 3.

■ Note :

- In such a case that a HDMI IN is assigned to two input sources or more, when these input sources are selected, the uncompressed digital video signals (and digital audio signals when the HDMI Audio Output is set to HDMI Passthrough) input into the same HDMI IN can be output from the HDMI MONITOR OUT of this receiver.

■ When selecting the Component Assign

- You should assign the connected COMPONENT VIDEO INs to the desired of VIDEO 1 ~ 4, EXT.IN.
(For details, refer to "CONNECTING VIDEO COMPONENTS" on pages 5 ~ 6.)
- You can select the desired of Component 1 ~ 2.

■ Note :

- In such a case that a COMPONENT VIDEO IN is assigned to two input sources or more, when these input sources are selected, the component video signals can be viewed from the same COMPONENT VIDEO IN.

■ When selecting the Audio Assign

- You should assign the connected DIGITAL INs to the desired of CD, F.AUX and VIDEO 1 ~ VIDEO 4, EXT.IN.
(For details, refer to "CONNECTING DIGITAL INS AND OUT" on page 7.)
- You can select the desired of Optical 1 ~ 2 and Coaxial 1 ~ 2.

■ Note :

- In such a case that a DIGITAL IN is assigned to two input sources or more, when these input sources are selected, the digital audio signals can be heard from the same DIGITAL IN.

■ When selecting the Video Mode

- Depending on the Video Mode settings, the video input signal can be converted and output from the HDMI MONITOR OUT.

Auto : When there are multiple video input signals, the video input signals are detected and the video input signal to be output from the HDMI MONITOR OUT is selected automatically in the priority order of them :
 ↓
 "HDMI" > "COMPONENT" > "S-VIDEO" > "(composite) VIDEO"

HDMI : The signal that is input into the HDMI IN connector is always played. The HDMI video input signal is output from the HDMI MONITOR OUT only.
 ↓

Component : The signals that are input into the COMPONENT IN jacks are always played.
 The component video signals are converted and output from the HDMI MONITOR OUT.
 ↓

S-Video : The signal that is input into the S-VIDEO IN jack is always played.
 The S-Video signal is converted and output from the HDMI MONITOR OUT.
 ↓

Composite : The signal that is input into the (composite) VIDEO IN jack is always played.
 The composite video signal is converted and output from the HDMI MONITOR OUT.

Continued

■When selecting the Audio Mode

- You can select the desired audio input signal to be played.

■Notes :

- Be sure to set the Audio Mode to the audio input which is connected and assigned to the selected input source.
- When the HDMI Audio Output is set to HDMI Passthrough, no sound will be heard from the speakers connected to this receiver (except ROOM 2 speakers).
- When the Audio Mode is set to HDMI, you should connect the HDMI INs and set the HDMI Assign correctly. If not, the HDMI input flickers on the unit's display and no sound will be heard.
- When the Audio Mode is set to Digital, you should connect the DIGITAL INs and set the Audio Assign correctly. If not, the digital input flickers on the unit's display and no sound will be heard.

Auto : When there are multiple audio input signals, the audio input signals are detected and the audio input signal to be played is selected automatically in the priority order of them :

↓
HDMI audio > DIGITAL audio > ANALOG audio

HDMI : The signal that is input into the HDMI IN is always played.

↓

Digital : The signal that is input into the OPTICAL or the COAXIAL DIGITAL IN is always played.

↓

Analog : The signal that is input into the analog AUDIO INs is always played.

■When selecting the Video Scaling

- You should set the resolution of video signals to be output from the HDMI MONITOR OUT to match that of your TV. (For details on the resolution compatible with your TV, refer to the operating instructions of your TV.)
- When the HDMI MONITOR OUT is connected to an HDMI-compatible TV, the TV reports to this unit what resolutions it supports. Therefore, if you set the Video Scaling to "Auto", this unit outputs the video signals of the optimum resolution acceptable for your TV.

■Notes :

- If the resolutions of the video signals which are output from the HDMI MONITOR OUT and your TV are not matched, the picture is not clear, natural or displayed.
- When 1080/24p video signals are input into the HDMI IN, the Video Scaling is automatically set to "HDMI Bypass".
- When the Video Mode is set to "S-Video" or "Composite" and the Video Scaling is set to "HDMI Bypass", the 576p video signals will be output from the HDMI MONITOR OUT.
- When the Video Scaling is set to "HDMI Bypass" and the video signals are input into the HDMI IN, the momentary OSD cannot be displayed via HDMI MONITOR OUT.

Auto : To convert the video signals being input to the video signals of the highest resolution acceptable for TV and to output them from the HDMI MONITOR OUT.

↓
HDMI Bypass : To output the video signals at the same resolution that they are input, with no conversion.

↓

480p/576p : To convert the video signals to 480p(NTSC)(or 576p(PAL)) video signals and to output them.

↓

720p : To convert the video signals to 720p video signals and to output them.

↓

1080i : To convert the video signals to 1080i video signals and to output them.

↓

1080p : To convert the video signals to 1080p video signals and to output them.

■When selecting the AV Sync

- There may be a slight time delay between the video and audio signals in case that some video playback equipments may process the video signals later than the audio signals due to signal processing procedure, etc.. Should this happen, you can adjust the time delay of audio signals to synchronize the sound with the picture.
- The time delay can be adjusted within the range of 0 ~ 200 msec.

Continued

■ When selecting the HD Audio

- When the source components that cannot support the HD audio signal format (such as Dolby Digital Plus, Dolby TrueHD, DTS-HD High Resolution Audio, DTS-HD Master Audio, etc.) are connected to the HDMI IN of this receiver, some components may not output any audio signals from its HDMI OUT.
In this case, you should set the HD Audio to Off to play the audio signals other than the HD audio signals. (For details on the audio signal format, refer to the operating instructions of the source component.)

On : To play the audio signals (including the HD audio signals).



Off : To play the audio signals other than the HD audio signals.

When selecting the Re-Name

- You can give names to the input sources other than tuner.
- Up to 8 characters can be entered for each name.

- Press the CURSOR UP/DOWN buttons to select the desired input source, then press the CURSOR RIGHT button to enter the setting menu.
- Press the CURSOR UP/DOWN buttons to select the Re-Name, then press the CURSOR RIGHT button to enter the setting menu.

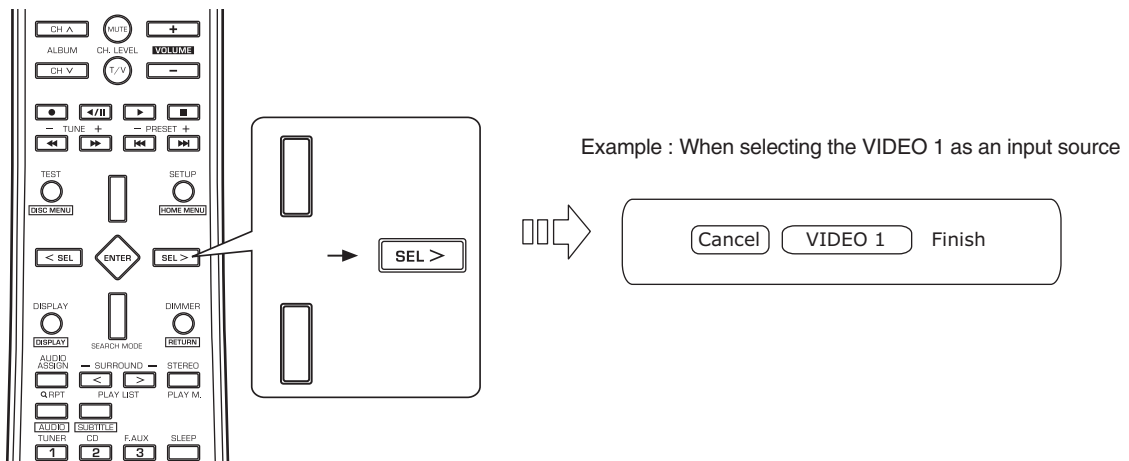

Continued

3. Press the CURSOR LEFT/RIGHT buttons to select the desired digit.

- Then the cursor moves to the desired digit.

4. Press the CURSOR UP/DOWN buttons to enter the desired character on the selected digit.

- You can enter the desired among blank, A~Z, a~z, 0~9, (,), +, ,, - , ., /.

5. Repeat the above steps 3 and 4 to enter the desired characters on the rest of the digits.

■ **To resume its factory input source name**

- Enter a blank on each digit.

6. To confirm your entry, press the CURSOR RIGHT button to select the Finish, then press the ENTER button.

- The name is stored in the memory.

■ **To clear the name you entered**

- Press the CURSOR LEFT button to select the Cancel, then press the ENTER button.

SETTING THE MULTI ROOM SETUP

- The Room 2 function allows enjoying one source in the main room while playing another in a different room at the same time.

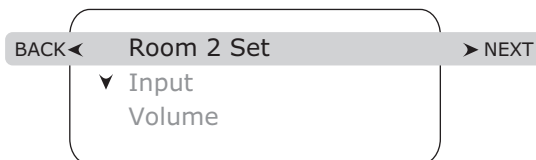

- Room 2 : To turn on or off the ROOM 2 function.
- Input : To select the desired ROOM 2 source.
- Volume : To adjust the volume on the power amplifier assigned to "Surr Back ↔ Room 2" or "Room 2".

■ Notes:

- The analog signals from the EXTERNAL INs and the digital signals cannot be output to the different room, meaning no playback in a different room.
- Only the (composite) video signals can be output to the different room.

1. Press the CURSOR UP/DOWN buttons to select the desired item, then press the CURSOR RIGHT button to enter its setting menu.

2. Press the CURSOR UP/DOWN buttons to set the selected item as desired, then press the ENTER button.

- When the CURSOR LEFT button is pressed on a setting menu, the previous menu will be returned to.
- When adjusting the Volume, use the CURSOR UP/DOWN buttons only.

When selecting the Room 2

On : To turn on the Room 2 function.



Off : To turn it off.

■ Notes:

- When the Room 2 is set to Off, the Input and the Volume cannot be selected.
- When you do not use the Room 2 function, set the Room 2 to Off to save electricity.

When selecting the Input

- You can select the desired among Main source, Video 1 ~ Video 4, CD, Tape, F.AUX, Tuner as a ROOM 2 source.

■ Note:

- When the EXTERNAL IN is selected as a main input, if the Main source is selected as a Room 2 input, no audio signal can be heard in the different room (ROOM 2).

When selecting the Volume

- You can adjust the volume on the power amplifier assigned to "Surr Back ↔ Room 2" or "Room 2" when the ROOM 2 speaker terminals are connected to the speakers in a different room.(For details, refer to "When selecting the AMP Assign" on page 41.)

■ Note:

- The Volume setting is invalid when the AMP Assign is assigned to "Bi AMP" or "Surround Back".

SETTING THE SOUND PARAMETER

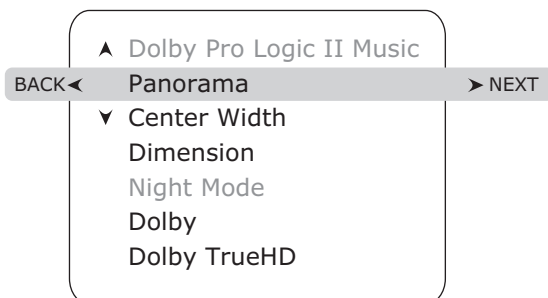

- Dolby Pro Logic II Music : To adjust the various surround parameters for optimum surround effect.
- Night Mode : To adjust the dynamic range compression that makes faint sound easier to hear at low volum levels.

1. Press the CURSOR UP/DOWN buttons to select the desired itme, then press the CURSOR RIGHT button to enter its setting menu.

2. Press the CURSOR UP/DOWN buttons to set the selected item as desired, then press the ENTER button.

- When the CURSOR LEFT button is pressed on a setting menu, the previous menu will be returned to.

When selecting the Dolby Pro Logic II Music

- You can adjust the various surround parameters for optimum surround effect.

■ Note:

- The parameter settings are valid only when listening in either Dolby Pro Logic II Music mode or the Dolby Pro Logic IIx Music mode.

■ When selecting the Panorama

This mode extends the front stereo image to include the surround speakers for an exciting "wraparound" effect with side wall imaging. Select "Off" or "On"(default value:Off).

■ When selecting the Center Width

This adjusts the center image so it may be heard only from the center speaker, only from the left/right speakers as a phantom image, or from all three front speakers to varying degrees. The control can be set in 8 steps from 0 to 7 (default value : 3).

■ When selecting the Dimension

This gradually adjusts the soundfield either towards the front or towards the rear. The control can be set in 7 steps from -3 to +3(default value : 0).

When selecting the Night Mode

- This function compresses the dynamic range of previously specified parts of the Dolby Digital or Dolby TrueHD sound track (with extremely high volume) to minimize the difference in volume between the specified and non-specified parts. This makes it easy to hear all of the sound track when watching movies at night at low levels.

■ Notes:

- The night mode setting is valid only when the digital signals from the Dolby Digital or Dolby TrueHD program source are being input.
- In some Dolby Digital softwares, the night mode setting may not be valid.

■ When selecting the Dolby

Off ↑ Lower compression
 ↓
 Low
 ↓
 Mid ↓ Higher compression
 ↓
 High ↓

■ When selecting the Dolby TrueHD

Auto : To adjust the dynamic range compression automatically.
 ↓
 Off ↑ Lower compression
 ↓
 Low
 ↓
 Mid ↓ Higher compression
 ↓
 High ↓

SETTING THE ADVANCED VIDEO

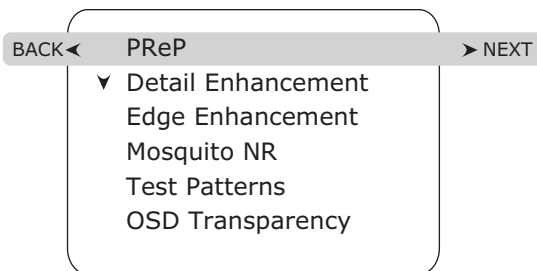

- PReP : To improve the progressive video signal by progressive reprocessing.
- Detail Enhancement : To enhance the entire picture by making details stand out.
- Edge Enhancement : To enhance the picture by shapening object edges.
- Mosquito NR : To remove the mosquito noise.
- Test Patterns : To select the desired test pattern.
- OSD Transparency : To adjust the tranparency of OSD background.

1. Press the CURSOR UP/DOWN buttons to select the desired itme, then press the CURSOR RIGHT button to enter its setting menu.

2. Press the CURSOR UP/DOWN buttons to set the selected item as desired, then press the ENTER button.

- When the CURSOR LEFT button is pressed on a setting menu, the previous menu will be returned to.
- When adjusting the Detail Enhancement, the Edge Enhancement or the OSD Transparency, use the CURSOR UP/ DOWN buttons only.

When selecting the PReP

- The PReP has an effect on the 576p or the 1080p video signals only.
Auto : To improve the progressive video signal automatically.
↓
Off : To turn off the progressive reprocessing.

When selecting the Detail Enhancement

- The detail enhancement can be adjusted within the range of -10 ~ + 10.

When selecting the Edge Enhancement

- The edge enhancement can be adjusted within the range of -10 ~ + 10.

When selecting the Mosquito NR

- The Mosquito Noise Reduction applies filtering to the image noise that is caused by video compression processing to remove the noise.
Off : To turn off the filtering.
↓
Low : Minimun filtering.
↓
High : Maximun filtering.

When selecting the Test Patterns

- You can select the desired among Off(no display), Frame Geometry, Bright/Contrast, Checker Board, Vertical Lines, Horizontal Lines, Judder, Color8 Bars 75 and Color8 Bars 100.
■ **Note:**
• The Horizontal Lines can be selected only when the progressive video signals (576p, 720p or 1080p) are output from the HDMI MONITOR OUT.

When selecting the OSD Transparency

- You can adjust the transparency of OSD background as desired.
Low : To adjust the transparency low.
↓
Mid : To adjust it to mid level.
↓
High : To adjust high.

Troubleshooting Guide

If a fault occurs, run through the table below before taking your receiver for repair.

If the fault persists, attempt to solve it by switching the receiver off and on again. If this fails to resolve the situation, consult your dealer. Under no circumstances should you attempt to repair the receiver yourself. This could void the warranty.

PROBLEM	POSSIBLE CAUSE	REMEDY
No power	<ul style="list-style-type: none"> The AC input cord is disconnected. Poor connection at AC wall outlet or the outlet is dead or off. 	<ul style="list-style-type: none"> Connect cord securely. Check the outlet using a lamp or another appliance.
No sound	<ul style="list-style-type: none"> The speaker wires are disconnected. The master volume is adjusted too low. The MUTE button is pressed to ON. Incorrect selection of input source. Incorrect connections between the components. The HDMI Audio Output is set to HDMI Passthrough. The settings related to audio are set incorrectly. 	<ul style="list-style-type: none"> Check the speaker connections. Adjust the master volume. Press the MUTE button to cancel the muting effect. Select the desired input source correctly. Make connections correctly. Set it to Speaker. (For details, refer to "When selecting the HDMI Audio Output" on page 41.) Set the settings correctly. (For details, refer to "SETTING THE INPUT SETUP" on page 51.)
No sound from the surround speakers	<ul style="list-style-type: none"> Surround mode is switched off(stereo mode). Master volume and surround level are too low. Monaural source is used. Surround speaker setting is "No". 	<ul style="list-style-type: none"> Select a surround mode. Adjust master volume and surround level. Select a stereo or surround source. Select the desired surround speaker setting.
No sound from the center speaker	<ul style="list-style-type: none"> Dolby Virtual Speaker, stereo mode, etc is selected. Center speaker setting is "No". Master volume and center level are too low. 	<ul style="list-style-type: none"> Select the desired surround mode. Select the desired center speaker setting. Adjust master volume and center level.
No sound from the surround back speakers	<ul style="list-style-type: none"> The input signal format or the current surround mode cannot support the 7.1(or 6.1) surround. The surround back channels' power amplifier is assigned to "Bi AMP" or "Room 2". Master volume and surround back level are too low. Surround back speaker setting is "No". 	<ul style="list-style-type: none"> Under the proper situations, perform the 7.1(or 6.1) surround playback. (For details, refer to "ENJOYING SURROUND SOUND" on page 23.) Assign the power amplifier to the surround back channels. (For details, refer to "When selecting the AMP Assign" on page 41.) Adjust master volume and surround back level. Select the desired surround back speaker setting.
No picture	<ul style="list-style-type: none"> Video connections between this unit and the monitor TV are not made correctly. Incorrect selection of input source on the monitor TV. The settings related to video are set incorrectly. 	<ul style="list-style-type: none"> Make proper video connections. Select the input source correctly. Set the settings correctly. (For details, refer to "SETTING THE INPUT SETUP" on page 51.)
No picture with an HDMI connection	<ul style="list-style-type: none"> HDMI connection between this unit and the monitor TV are not made correctly. The monitor TV or other equipments do not support HDCP. 	<ul style="list-style-type: none"> Make proper HDMI connection. This unit will not output video signal unless the connected equipments supports HDCP.
Noise or distorted picture	<ul style="list-style-type: none"> Video format of your monitor TV, DVD player, etc. is different from PAL. 	<ul style="list-style-type: none"> Change the video format to PAL.
Stations cannot be received	<ul style="list-style-type: none"> No antenna is connected. The desired station frequency is not tuned in. Antenna is in wrong position. 	<ul style="list-style-type: none"> Connect an antenna. Tune in the desired station frequency. Move antenna and retry tuning.
Preset stations cannot be received	<ul style="list-style-type: none"> An incorrect station frequency has been memorized. The memorized stations are cleared. 	<ul style="list-style-type: none"> Memorize the correct station frequency. Memorize the stations again.
Poor FM reception	<ul style="list-style-type: none"> No antenna is connected. The antenna is not positioned for the best reception. Weak signals. 	<ul style="list-style-type: none"> Connect an antenna. Change the position of the antenna. Install an outdoor FM antenna.
Continuous or intermittent hissing noise during AM reception, especially at night.	<ul style="list-style-type: none"> Noise is caused by motors, fluorescent lamps or lightning, etc. 	<ul style="list-style-type: none"> Keep the receiver away from noise sources. Install an outdoor AM antenna.
Remote control unit does not operate.	<ul style="list-style-type: none"> Batteries are not loaded or exhausted. The remote sensor is obstructed. 	<ul style="list-style-type: none"> Replace the batteries. Remove the obstacle.
OSD function is not available.	<ul style="list-style-type: none"> Video connections between this unit and the monitor TV are not made correctly. 	<ul style="list-style-type: none"> Make proper (composite) video connections.

Specifications

■ AMPLIFIER SECTION

- Power output, stereo mode, 6 Ω , THD 1.0 %, 40 Hz~20 kHz | **2 \times 100 W**
- Total harmonic distortion at -3 dB, 6 Ω , 1 kHz | **0.01%**
- Intermodulation distortion
60 Hz : 7 kHz = 4 : 1 SMPTE, 6 Ω , 95 W | **0.01%**
- Input sensitivity/impedance
Line (CD, TAPE, VIDEO) | **300 mV/47k Ω**
- Signal to noise ratio, IHF "A" weighted
Line (CD, TAPE, VIDEO) | **100 dB**
- Frequency response
Line (CD, TAPE, VIDEO), 10 Hz ~ 100 kHz | **+0, -3 dB**
- Output level
ROOM 2 OUT, 2.2 k Ω | **300 mV**
- Bass/Treble control, 100 Hz/10 kHz | **\pm 10 dB**
- Surround mode, only channel driven
Front power output, 6 Ω , 1 kHz, THD 1.0 % | **110 W / 110W**
Center power output, 6 Ω , 1 kHz, THD 1.0 % | **110 W**
Surround power output, 6 Ω , 1 kHz, THD 1.0 % | **110 W / 110W**
Surround back (/MULTI) / ROOM 2 power output, 6 Ω , 1 kHz, THD 1.0 % | **110 W / 110W**

■ DIGITAL AUDIO SECTION

- Sampling frequency | **32, 44.1, 48, 96, 192 kHz**
- Digital input level
Coaxial, 75 Ω | **0.5 Vp-p**
Optical, 660 nm | **-15 ~ -21 dBm**

■ VIDEO SECTION

- Video format | **PAL**
- Input sensitivity(=Output level), 75 Ω
Video (Composite(normal)) | **1 Vp-p**
S-Video (luminance signal) | **1 Vp-p**
(chrominance signal) | **0.286 Vp-p**
Component video (R-Y signal) | **0.5 Vp-p**
(B-Y signal) | **0.5 Vp-p**
(Y signal) | **1.0 Vp-p**
- HDMI connector | **19 pin**

■ FM TUNER SECTION

- Tuning frequency range | **87.5~108 MHz**
- Usable sensitivity, THD 3%, S/N 26 dB | **12.8 dBf**
- 46 dB quieting sensitivity, mono/stereo | **20.2 / 45.3 dBf**
- Signal to noise ratio, 65 dBf, mono/stereo | **70 / 65 dB**
- Total harmonic distortion, 65 dBf, 1 kHz, mono/stereo | **0.5 / 0.8 %**
- Frequency response, 30 Hz~15 kHz | **\pm 3 dB**
- Stereo separation, 1 kHz | **32 dB**
- Capture ratio | **4.0 dB**
- IF rejection ratio | **60 dB**

■ AM TUNER SECTION

- Tuning frequency range | **522~1611 kHz**
- Usable sensitivity | **500 μ V/m**
- Signal to noise ratio | **40 dB**
- Selectivity | **25 dB**

■ GENERAL

- Power supply | **230V ~ 50 Hz**
- Power consumption | **350 W**
- Dimensions (W \times H \times D, including protruding parts) | **435x166x374 mm(17-3/8x6-1/2x14-3/4 inches)**
- Weight (Net) | **9.5 kg (20.9 lbs)**

Note: Design and specifications are subject to change without notice for improvements.

Setup Code Table

TV

ADMIRAL	050	134				
AKAI	093	049	123			
ALBA	068					
ALBIRAL	116					
ALCATEL	022					
AMSTRAD	158	021				
ANAM	155	156	157			
ARC EN CIEL	028	039	043	145	081	
ARISTONA	099	049	050	019	142	149
	078					
ARTHUR MARTIN	053	139	117	120	122	123
	125	128				
ASA	050	055	057	113	134	
ATLANTIC	099	111				
AUDIOSONIC	054					
AUSIND	053					
AUTOVOX	099	144	055	019	057	069
BAIRD	083					
BASICLINE	006					
BAUR	011					
BEKO	023	049				
BLAUPUNKT	094	100	102	111	114	
BENQ	159					
BRANDT	028	039	040	043	145	081
BRION VEGA	050					
BRUNS	048	050				
BSR	059	110	132			
BUSH	033	068	124	074		
CENTURY	098	101	050	079	136	
CGE	016	101	124	079	132	136
CIHAN	065					
CLARIVOX	048	116				
CONDOR	099	111				
CONTEC	087					
CONTINENTAL						
EDITION	028	039	040	043	145	081
CROSLEY	101	050	109			
CROWN	147					
CTC CLATRONIC	046					
DAEWOO	089					
DECCA	099	060	063	115	118	
DEGRAAF	036					
DIXI	049	090				
DRYNATRON	049					
DUAL	099	141				
DUAL-TEC	096	099	132			
DUMONT	046	050	057	073		
ELBE	016	116				
ELBIT	065					

ELCIT	046	097	103	050	109	127
	132					
ELMAN	046	132				
ELTA	090					
EMERSON	158	098	050			
ERRES	049	142				
EUROPHON	098	046	097	099	051	115
	132					
FERGUSON	146	040	041	150	057	061
	116	149				
FIDELITY	099	149				
FINLUX	034	046	053	055	057	109
	113	073	074	079		
FISHER	015	048	050	052	109	136
FORGESTONE	149					
FORMENTI	099	053	109	111	125	
FORTRESS	137					
FRABA	075					
FRONTECH	054					
FUJITSU	025					
FUNAI	054	059				
GBC	109	132				
GEC	099	060	109	115	134	088
GELOSO	103	109	132	134	090	
GOLDSTAR	092	003	017	099	049	075
	076	077	090	152		
GOODMANS	033	049	060	077		
GORENJE	066	136				
GREATZ	001	058	109	122	123	128
	129	130	134			
GRANADA	033	099	049	058	060	142
	115	125	134			
GRUNDIG	094	100	057	058	108	112
	114	082				
HANSEATIC	033	047	099	049	109	139
	111					
HANTAREX	097					
HEMMERMANN	127					
HIFIVOX	028	039	043	145	081	
HINARI	158	033	045	143	090	
HITACHI	014	033	034	036	099	145
	056	109	139	110	067	117
	132	134	084	091	081	088
HYPER	093	099				
IMPERIAL	016	101	124	079	132	133
INGELEN	001	058	109	122	128	129
	130	134				
SHERWOOD	000	001	002			

INNO HIT	093	098	097	099	143	077
	090					
INTERFUNK	047	049	050	145	058	109
	142	123	128	129	091	
IRRADIO	093	143	053	077	090	
ITT	001	140	058	105	109	122
	123	128	148	129	130	134
	135	083	089			
JVC	033	154				
KTV	099					
KAISUI	006					
KARCHER	006					
KENDO	098					
KENNEDY	144	019	109			
KORTING	050	059	111			
KRIESLER	099	049	050	019	142	149
	078					
LENOIR	099					
LOEWE OPTA	008	097	047	049	050	115
	072					
LOGIK	118	149				
LUMA	049	120	134			
LUXOR	058	139	117	120	123	129
	135	083				
MAGNADYNE	046	097	103	050	109	115
	127	132				
MAGNAFON	046	097	099	051	053	115
MARANTZ	049					
MATSUI	158	099	106	060	118	068
	134	090				
McMICHAEL	088					
MEMOREX	090					
METZ	094	050	114	133		
MINERVA	094	100	057	058	114	
MISTRAL	149					
MITSUBISHI	033	035	047	049	050	062
	118	119	148	080	138	
MIVAR	097	099	115	077		
MULTITECH	046	099	115	136		
MURPHY	134					
MAONIS	096	144	019	110	134	
NATIONAL	042	104	109			
NEC	033	085				
NECKERMANN	099	050	139	120	136	
NEI	049					
NIKKAI	060					
NOBLEX	015					
NOBLIKO	098	046	099	053	057	
NOGAMATIC	028	039	043	145	081	
NOKIA	161	140	058	105	109	122
	123	128	148	129	130	134
	135	083	089			

NORDMENDE	028	032	039	043	145	131
	091	081				
OCEANIC	109	064	123			
ONCEAS	099					
OPTONICA	137					
ORION	158	059	118	068	127	090
OSAKI	060					
OSIO	077					
OSUME	087					
OTTO VERSAND	033	047	049	109	139	
P.T ACTTRON	065					
PAEL	099	053				
PANASONIC	030	042	095	104	107	109
	121	126				
PATHE CINEMA	099	111	116	132		
PERDIO	060					
PHILCO	016	030	101	050	109	124
	079	132	136			
PHILIPS	009	010	013	018	024	099
	049	050	019	142	148	149
	078	088				
PHOENIX	099	053	109	111	125	
PHONOLA	099	049	050	019	142	149
	078					
PIONEER	020	049	145	091		
PRANDONI-						
PRINCE	098	097	053	115	134	
PREMIER	124					
PRINCE	098	097	053	134		
PROTECH	049	054				
PYE	099	049	050	019	142	148
	149	078				
QUASAR	046	097	051	053	077	
QUELLE	047	099	100	049	053	055
	057	058	111	112	113	114
	118	123	073	074	128	
RADIOLA	099	049	050	019	142	149
	078					
RADIOMARELLI	046	097	103	050	109	062
	127	132				
RANK	074					
RBM	074					
REDIFFUSION	062	123	134			
REX	096	144	019	141	110	069
	134					
ROBOTRON	048	050				
RTF	048	050				
SABA	028	031	032	037	039	040
	043	097	050	145	115	120
	086	091	081			
SAISHO	158	099	118	119	068	090
SALORA	053	139	117	120	122	123
	125	128	135	083		

SAMBERS	046	097	051	053	115	077
SAMPO	121					
SAMSUNG	015	026	099	054	077	136
	090	151	153			
SANYO	161	162	005	033	044	048
	060	113	118	071	054	136
SBR	049	142	148	149	088	
SCHAUB LORENZ	161	058	109	122	123	128
	129	130	134			
SCHNEIDER	096	099	049	050	052	019
	141	109	142	125	149	078
	132					
SEG	046					
SEI	158	059				
SELECO	016	096	144	019	141	110
	069	134				
SHARP	033	087	137			
SIAREM	046	097	050	109	115	
SICATEL	116					
SIEMENS	005	094	036	100	111	114
	087					
SIERA	099	049	050	019	142	149
	078					
SILVER	054					
SINGER	016	046	050	109		
SINUDYNE	158	046	050	059	109	127
SONOKO	049	090				
SONY	146	007	027	033	038	118
STERN	096	144	019	110	069	134
TANDBERG	133					
TANDY	099	060	137			
TASHIKO	162	033				
TATUNG	099	060	063	065	115	118
TEC	096	099	132			
TELEAVIA	028	039	040	043	145	091
	081					
TELEFUNKEN	028	041	145	150	086	091
TELETECH	090					
TELEVIDEON	099	053	109	111	125	
TENSAI	049					
THOMSON	012	028	032	039	040	043
	145	091	081			
THORN- FERGUSON	014	040	041	054	150	057
	061	116	149	086		
TOCOM	029					
TOSHIBA	004	016	033	070	074	
TRANS						
CONTINENTS	098	097	053	134		
TRIUMPH	158					
UHER	052	111	125			
ULTRA VOX	098	046	099	050	109	120

UNIVERSUM	092	034	054	077		
UNIVOX	116					
VEGAVOX	079					
VOXSON	050	134				
WATSON	111					
WATT RADIO	046	099	051	109	116	127
WEGA	033					
WHITE						
WESTINGHOUSE	099	111				
YOKO	099					
ZANUSSI	096	144	019	110	069	134
ZOPPAS	096	144	019	110	134	

DOCK-VCR

AKAI	042	022	052	032	033	
ALBA	008	020				
AMSTRAD	011					
ANITSCH	009					
ARC EN CIEL	042	056	052			
ARISTONA	045	031				
ASA	018					
AWIA	011	042				
BAIRD	042	033				
BAUER. BOSCH	014	043				
BLAUPUNKT	014	043	055	031	054	040
BRANDT						
ELECTRONIQUE	042	056	052			
BRIONVEGA	041					
BUSH	008	020				
C.EDISON	041					
CANON	014					
CAPEHART	020					
CGE	011	042	052			
CONTINENTAL						
EDISON	042	056	052			
CRAIG	064	013				
CURTIS MATHES	019					
DAEWOO	001	020	021			
DAYTRON	020					
DECCA	011	042				
DEGRAAF	003	006	011	045	018	
DUAL	042	052				
DUMONT	003	011	018			
DYNATECH	011					
EMERSON	002	010	011	019	025	
FERGUSON	042	059	030	052	034	036
FIDELITY	011					
FINLANDIA	003	018				
FINLUX	003	006	011	018		
FISHER	000	003	005			

FUNAI	011					
GE	019					
GENERAL	014					
GOLDSTAR	004	062				
GOODMANS	008	011	046			
GRAETZ	041	042	056	050	052	038
GRANADA	003	005	018			
GRUNDIG	014	043	018	055	031	053
	054					
HANSEATIC	043					
HARMAN-						
KARDON	004					
HIFIVOX	042	056	052			
HINARI	002	008	024	027		
HITACHI	006	007	011	042	057	
IMPERIAL	011					
INGELEN	042	056	052	038		
INGERSOL	027					
ITT	005	041	042	056	050	052
	033	038				
JENSEN	042					
JVC	042	056	060	030	052	063
KENWOOD	005	042	060			
KRIESLER	045	031				
KUBA	043					
LLOYD	011					
LOEWE OPTA	014	018	029	031		
LOGIK	008	027				
LUXOR	033	038				
MAGNADYNE	041					
MAGNASONIC	038					
MAGNAVOX	019					
MARANTZ	004	014	046	018	031	
MATUI	010	025	027			
MEMOREX	064	003	005	011	045	
METZ	014	043	031	054	037	
MGA	017					
MINERVA	055	054				
MINOLTA	006	007				
mitsubishi	060	017	049			
MTC	011	013				
MULTITECH	008	011				
MURPHY	011					
NAONIS	042	056	052			
NATIONAL	040					
NEC	004	042	060	052		
NECKERMANN	002	041	014	042	052	
NOGAMATIC	042	056	052			
NOKIA	003	005	041	042	056	050
	052	033	038			
NORDMENDE	039	042	056	052	053	035
OPTONICA	045	046				
ORION	002	010	025	027		

OSAKI	011					
OTTO VERAND	043					
P. CINEMA	014					
PALLADIUM	041	014				
PANASONIC	023	051	040			
PATHE MARCONI	042	056	052			
PENTAX	006	007				
PERDIO	011					
PHILIPS	012	014	045	046	018	029
	031					
PHONOLA	014	045	018	029	031	
PIONEER	060					
PORTLAND	020					
PROLINE	011					
PYE	014	045	018	029	031	
QUARTZ	005					
QUELLE	002	044	054			
RADIOLA	045	031				
RADIOMARELLI	041					
RCA	019					
REALISTIC	064	003	005	011	013	045
	046					
REX	042	056	052			
SABA	039	042	056	052	035	
SAISHO	002	010	025	027		
SALORA	005	017				
SAMSUNG	013	019	032	061		
SANSUI	042	060				
SANYO	064	003	005	025	038	
SBR	018	029				
SCHAUB LORENZ	041	042	056	050	052	038
SCHNEIDER	008	011	045	031		
SEI-SINUDYNE	027					
SELECO	042	056	052			
SENTRA	020					
SHARP	045	046	105	048		
SHERWOOD	000					
SHINTOM	008					
SIEMENS	014	043	055	031	054	038
SIERA	045	031				
SINUDYNE	027					
SONY	044	015	016	026	028	
STERN	042	056	052			
STS	006					
SUNKAI	025					
SYLVANIA	011	017				
SYMPHONIC	011	017				
TASHIKO	011					
TATUNG	011	042				
TEAC	011	042				
TEKNIKA	011					
TELEAVIA	042	056	052			
TELEFUNKEN	042	056	052			

TENOSAL	008					
THOMSON	042	056	052			
THORN- FERGUSON	039	042	059	030	052	034
	036					
TOSHIBA	001	042	056	017	058	052
TOTELEVISION	013					
UHER	042					
ULTRA VOX	041					
UNITECH	013					
UNIVERSUM	041	014	043			
URANYA	041					
VECTOR	004					
VICTOR	042	060				
VIDITAL	041					
WESTING HOUSE	041					
WARDS	019					
YAMAHA	004	042				
ZANUSSI	042	056	052			
ZENDER	052					
ZOPPAS	042	056				

BD/DVD

DENON	017					
GE	003	004				
JVC	007					
LG	011	010				
MAGNAVOX	019					
MITSUBISHI	001					
ONKYO	009					
PANASONIC	015					
PHILIPS	019					
PIONEER	002	023				
PROSCAN	003	004				
RCA	003	004				
SAMSUNG	016	008				
SHERWOOD	000	010	011	012	013	014
	022	020	021	024		
SONY	005					
THOMSON	003	004				
TOSHIBA	006					
VIETA	014					
YAMAHA	019					
ZENITH	011	010				

CBL

ABC	002	003	009	030		
	006	008				
Allegro	018	021				
Archer	018	026				
Bell&Howell	009					
Century	018					
Citizen	018	021				
Comtronics	014					
Contec	011					
Easten	001					
Emerson	026					
Everquest	010	014				
Focus	022					
Garrard	018					
Gemini	010					
General Instrument	033	276	006	034		
GoldStar	017	040				
Goodmind	026					
Hamlin	012	020	004	013		
Hitachi	006					
Jasco	010	018	021			
Jerrold	002	007	033	032	009	010
	006	034				
Movie Time	015					
NSC	015					
Oak	011					
Optimus	031					
Panasonic	016	031				
Philips	018					
Pioneer	017	025				
Popular Mechanics	022					
RCA	031					
Radio Shack	010	021	026	028		
Recoton	022					
Regal	012	020				
Regency	001					
Rembrandt	006					
SL Marx	014					
Samsung	017	014				
Scientific Atlanta	003	023	030	027		
SHERWOOD	000					
Signal	010	014				
Signature	006					
Sprucer	031					
Starcom	002	010				

Stargate	010	014	026
Starquest	010		
TV86	015		
Teleview	014		
Tocom	007	008	
Tusa	010		
Unika	018		
Universal	018	019	
Viewstar	015		
Zenith	024		
Zentek	022		

SAT

ALBA	030				
AMSTRAD	008	019	027		
ARCON	021				
ARISTONA	016				
ASTRA	028				
BLAUPUNKT	033				
BUSH	016				
CH.MASTER	030				
CITY COM	005				
DDC	030				
DYNASAT	005				
ECHOSTAR	002	009	032	020	
EMME ESSE	005				
FAIT	005				
FERGUSON	014	041	016	017	018
FINLUX	006	007	013		
FRACARRO	005				
FTE	022				
GOLDSTAR	004	021			
GRAETZ	026	037			
GROTHUSEN	004				
GRUNDIG	033	016	018	036	
HINARI	030				
HIRSCHMANN	003	006			
HITACHI	013				
INGELEN	026	037			
ITT	034				
ITT-NOKIA	032	018	026	037	
JERROLD	038	014			
KATHREIN	005	022	023		
KOSMOS	004				
KRIESLER	016				
LENCO	004	021			
LUXOR	026	037			

MAGAI	022				
MARANTZ	012				
MASPRO	016				
METZ	036				
MINERVA	036				
MULTISTAR	022				
MURATO	004				
NEC	040				
NEIRU	021				
NOKIA	026	037			
NORSAT	015				
PACE	001	042	016	017	018 044
PANASONIC	032				
PHILIPS	003	011	012	029	
PHONOLA	016				
PROSAT	030				
PYE	016				
QUADRAL	030				
QUELLE	036				
RADIOLA	016				
REDIFFUSION	015				
SABA	035				
SALORA	026				
SAMSUNG	003	022			
SAT PARTNER	004				
SATPORTNER	021				
SCHAUB LORENZ	026	037			
SCHNEIDER	005	016			
SHERWOOD	000				
SIEMENS	033	036			
SIERA	016				
SILVA	004	021			
SKY	039				
STARCOM	038				
STARSAT	022				
TECHNISAT	003				
TELEFUNKEN	025				
TELESYSTEM	005				
THORN- FERGUSON	010	014	041	016	017 018
	043				
TRIAD	004				
UNIDEN	022				
UNITED CABLE	038				
VTECHNOLOGY	004				
VORTEC	003	024	025		
ZENDER	022				

CD

ADCOM	021					
AIWA	045	039	022			
AKAI	046					
AUDIO	016					
ARC EN CIEL	036	014	027	030	031	018
	230					
DENON	054					
FISHER	006					
H/K	017	012	047	016		
JVC	028	034	001			
KENWOOD	003	020	010	029	006	
MARANTZ	015	014				
MONDIAL	033					
NAD	048	002	042			
NAKAMICHI	049					
NIKKO	016					
ONKYI	013	037	011	021	038	
PANASONIC	051	052				
PHILIPS	014					
PIONEER	005	008	041			
RCA	007	009				
REALISTIC	045					
SANSUI	040					
SHARP	019	053				
SHERWOOD	000	035	023	019	056	057
	058					
SONY	050	024	025	026		
TEAC	055	032				
TECHNICS	051	004	052			
VICTOR	001					
YAMAHA	044	043	016			

AUX-USBIMD

SHERWOOD	000(for USB)
	015 016(for MD recorder)

AUX-LD

DAEWOO	002
DENON	012
GOLDSTAR	004
KENWOOD	003
MAGNAVOX	010
OPTIMUS	007
PANASONIC	013
PHILIPS	010
POINNEER	000 009
RCA	006
REALISTIC	007
SAMSUNG	001 005
SHARP	003 011
TECHINCS	013
TOSHIBA	003
YAMAHA	008



RD-8504

Audio/Video Receiver



 **Sherwood**

